



# **SIP Intercom DP9 Series**







## **Quick Installation Guide**

# Contents

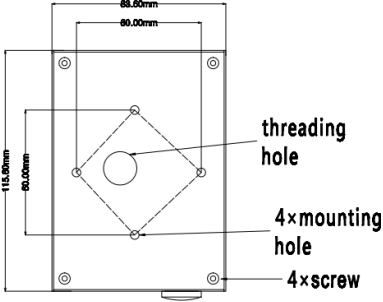
1 Packing List.....	3
2 Physical Specifications.....	4
3 Installation.....	8
4 Obtaining the device IP address.....	9
5 SIP Intercom Setting.....	9
6 Door Open Setting.....	11

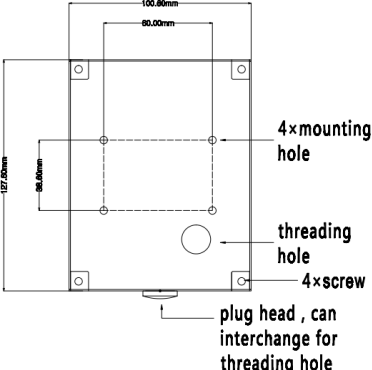
# SIP Intercom DP9 Series Quick Installation Guide

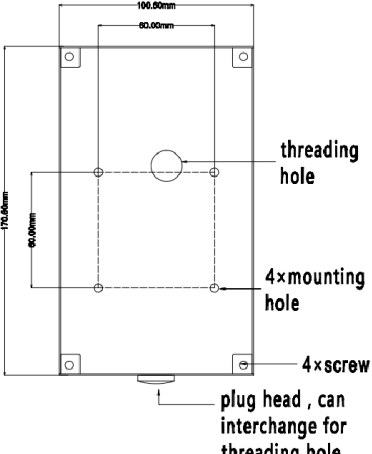
## 1 Packing List

SIP Intercom	Installation	Accessories
<p style="text-align: center;"><b>DP91</b></p> 	 <p style="text-align: right;">threading hole 4x mounting hole 4xscrew</p>	
<p style="text-align: center;"><b>DP92</b></p> 	 <p style="text-align: right;">4x mounting hole threading hole 4xscrew plug head , can interchange for threading hole</p>	
<p style="text-align: center;"><b>DP92V</b></p> 	 <p style="text-align: right;">threading hole 4x mounting hole 4xscrew plug head , can interchange for threading hole</p>	

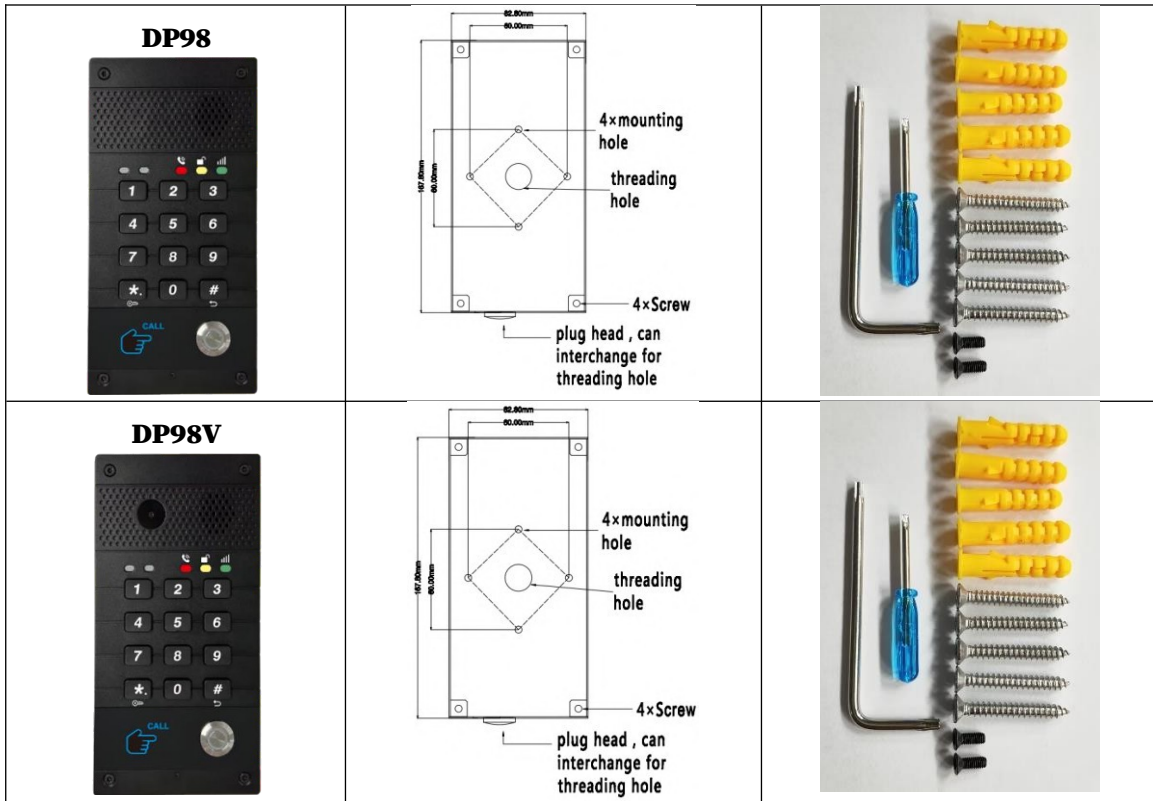

## 2 Physical Specifications

DP91 Device Dimension(L*W*H)	88*120*35 ( mm )
DP92 Device Dimension(L*W*H)	105*132*40 ( mm )
DP92V Device Dimension(L*W*H)	105*175*40 ( mm )
DP98 Device Dimension(L*W*H)	88*173*37 ( mm )
DP98V Device Dimension(L*W*H)	88*173*37 ( mm )

## 2.1 Front Panel (Part of the models)

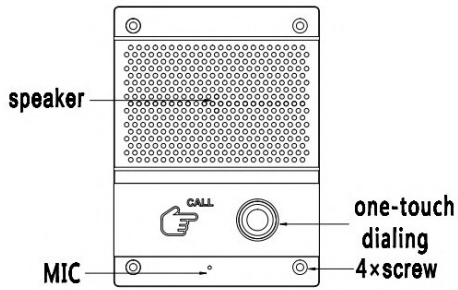

**DP91**

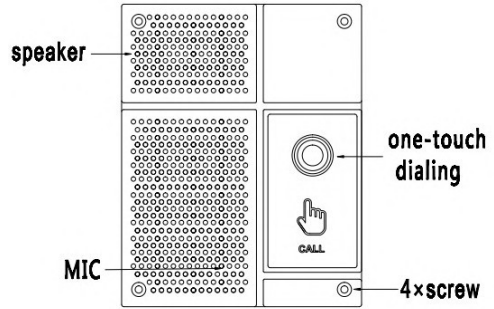

**DP92**

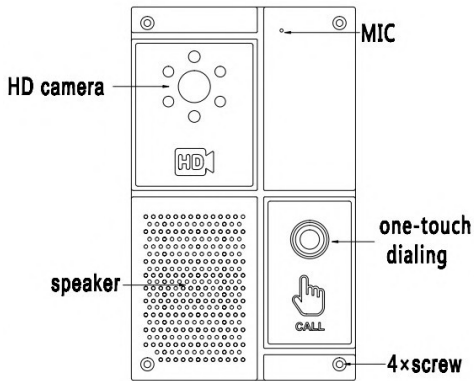

**DP92V**

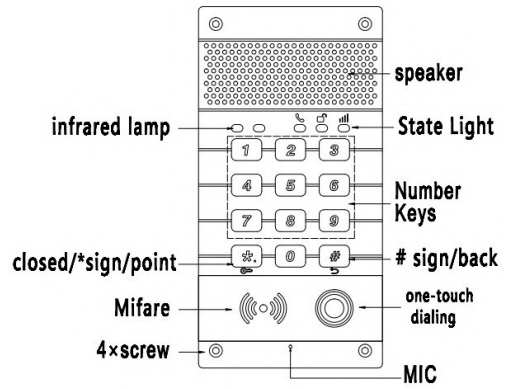

**DP98**

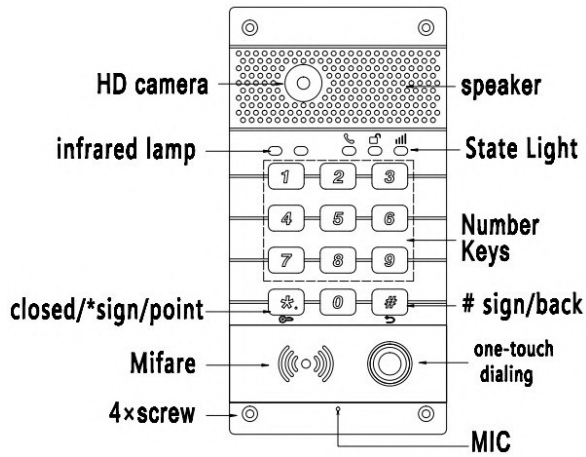

## 2.2 DP9 Series

	<b>Button</b>	<b>HD Camera</b>	<b>4G</b>	<b>Door Access</b>
<b>DP91-S</b>	Single	x	x	DTMF tones
<b>DP91-D</b>	Double	x	x	DTMF tones
<b>DP92-S</b>	Single	x	x	DTMF tones
<b>DP92-D</b>	Double	x	x	DTMF tones
<b>DP92-SG</b>	Single	x	√	DTMF tones
<b>DP92-DG</b>	Double	x	√	DTMF tones
<b>DP92V-S</b>	Single	√	x	DTMF tones
<b>DP92V-D</b>	Double	√	x	DTMF tones
<b>DP92V-SG</b>	Single	√	√	DTMF tones
<b>DP92V-DG</b>	Double	√	√	DTMF tones
<b>DP98-S</b>	Single	x	x	DTMF tones
<b>DP98-MS</b>	Double	x	x	DTMF tones, RFID card
<b>DP98V-S</b>	Single	√	x	DTMF tones
<b>DP98V-MS</b>	Double	√	x	DTMF tones, RFID card

## 2.3 Interface Description

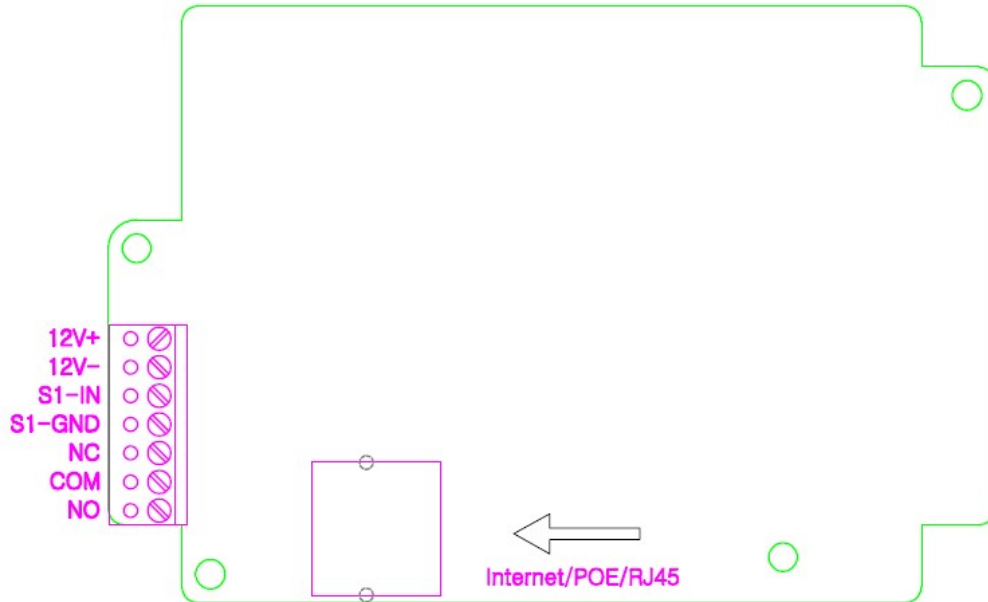

Name	Description
POE	Ethernet interface: standard RJ45 interface, 10/100M adaptive, it is recommended to use five or five types of network cable
12V+, 12V-	Power interface: 12V/1A input
S1-IN, S-GND	To connect indoor exit button or alarm input
NC, NO, COM	To connect door lock, alarm

## 2.4 Wiring Instructions

DP9 series only supports an external power supply to connect the electronic lock.

NO: Normal Open, idle status of the electric lock is opened COM:

COM1 interface

NC: Normal Closed, idle status of the electric lock is closed

External	Power off, door open	Power on, door open	Connections
√	√		
√		√	

## 3 Installation

### 3.1 Preparations

#### ( 1 ) Check the following contents

L-type screwdriver x 1 RJ45

plugs x2 (1 spare) KA4 X30

mm screws x 5

6×30mm expansion tube x 5 M3\*

8mm screws x 2

#### ( 2 ) Tools that may be required

L-type screwdriver

Screwdriver (Ph2 or Ph3), hammer, RJ45 crimper



Electric impact drill with a 6mm drill bit

### 3.2 Steps ( Take DP98V for example )

( 1 ) Drill four holes on the wall with a spacing of 60\*60 mm for the frame installation, then insert a plastic expansion tube, and next use KA4\*30 screws to tighten the back panel on the wall.

( 2 ) Put the front panel to the frame. With 4 X M3\*8mm screws. Tighten the front panel to the back panel on the wall.

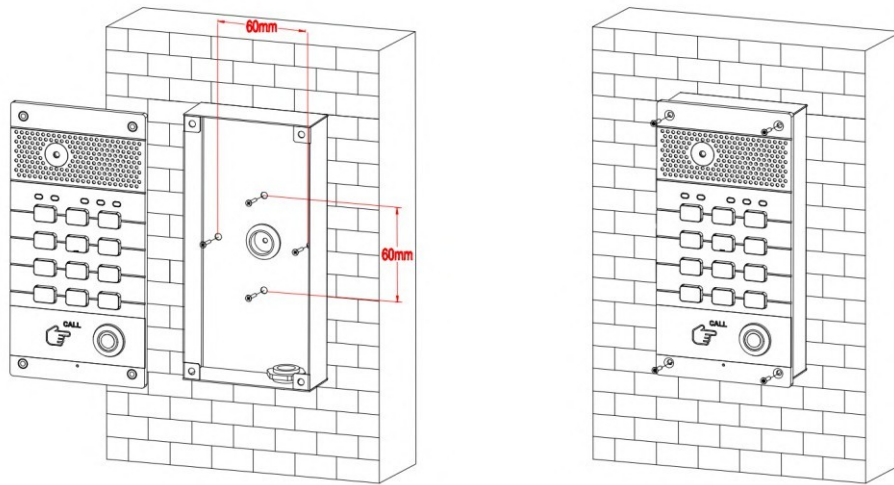

## 4 Obtaining the device IP address

After the device is powered on. By default, the device will get the IP address through DHCP. Press the dial key for **10 seconds** on the device panel, the intercom will voice broadcast the **IP address**.

## 5 SIP Intercom Setting

### 5.1 Log in the Device Web GUI

Access the device by entering the device IP (e.g. **http://192.168.1.131**) through the browser, and the device login interface will open after logging in. The default user name of the interface is admin and the password is admin.

<b>Username</b>	<input type="text"/>
<b>Password</b>	<input type="password"/>
<b>Language</b>	English <input type="button" value="v"/>
	<input type="checkbox"/> Remember Username/Password
	<input type="button" value="Login"/>

## 5.2 Add the SIP account

Configure the SIP account status, register name, username, password, and SIP server IP and port by assigning the SIP account on the server side respectively, and finally click the submit button.

Door Phone		
Status	Account	Network
Equipment	PhoneBook	Maintenance
Security		
<b>SIP Account</b>		
Status	Registered	
Account	Account1: 191 <input type="button" value="v"/>	
Active	Enabled <input type="button" value="v"/>	
Display Name	191	
Register Name	191	
Username	191	
Password	*****	
<b>SIP Server 1</b>		
Server IP	192.168.1.160	Port 5060
Registration Expires	1800	(30~65535s)

## 5.3 Set Door Access Parameters

Click "Equipment->Access" to set door access parameters. Including open door By DTMF Code, Access Card (RFID card & password) and HTTP (username & password of HTTP door open).

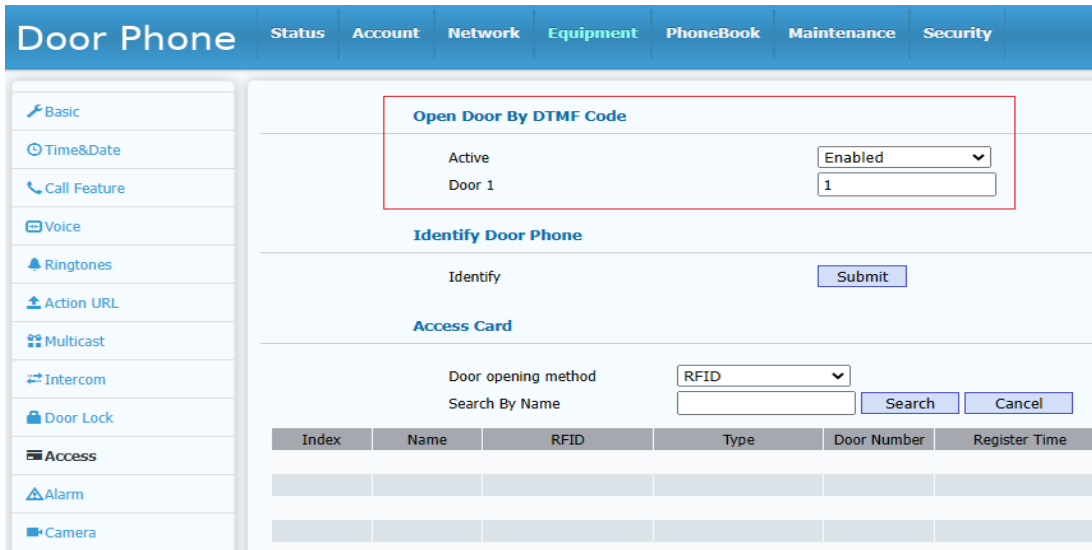

## 6 Door Open Setting

### 6.1 Open Door by DTMF Code

Click "Equipment->Access", select "**Open Door by DTMF Code**" to enable this function, and set the DTMF code for opening the door;

When the intercom calls the indoor monitor, during the call, the indoor monitor can send DTMF code to open the door.

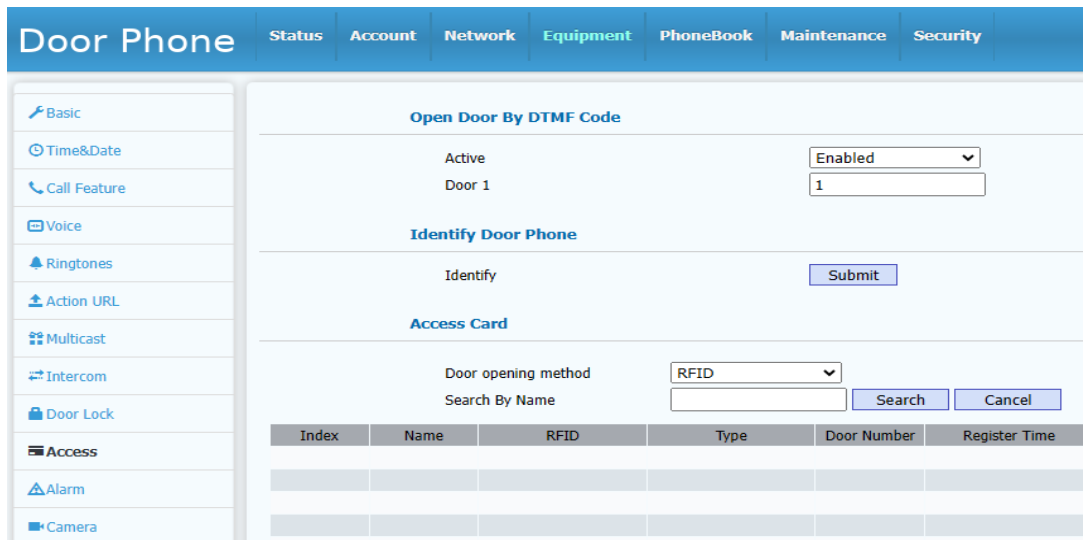

## 6.2 Open Door by RFID Card ( Only supported by some models )

Click "Equipment->Access", select "**Access Card**", swipe a new card to the intercom, then refresh the web GUI, RFID card number will be displayed on GUI automatically. then click "add";

The door can be opened successfully by swiping the card with the corresponding door card.

The screenshot shows the 'Door Phone' web interface. The top navigation bar includes 'Status', 'Account', 'Network', 'Equipment', 'PhoneBook', 'Maintenance', and 'Security'. The left sidebar lists various settings: Basic, Time&Date, Call Feature, Voice, Ringtones, Action URL, Multicast, Intercom, Door Lock, Access, Alarm, and Camera. The main content area is titled 'Access Card' and contains the following sections:

- Open Door By DTMF Code:** 'Active' is set to 'Enabled' and 'Door 1' is set to '1'.
- Identify Door Phone:** An 'Identify' button and a 'Submit' button are present.
- Access Card:** 'Door opening method' is set to 'RFID'. There is a 'Search By Name' input field with 'Search' and 'Cancel' buttons.

Index	Name	RFID	Type	Door Number	Register Time

## 6.3 Open Door By Password ( Only supported by some models )

Click "Equipment->Access", select "**Access Card-> password**", and add the correct password to open the door configuration;

Enter \*password# on the device panel to open the door.

The screenshot shows the 'Door Phone' web interface. The top navigation bar includes 'Status', 'Account', 'Network', 'Equipment', 'PhoneBook', 'Maintenance', and 'Security'. The left sidebar lists various settings: Basic, Time&Date, Call Feature, Voice, Ringtones, Action URL, Multicast, Intercom, Door Lock, Access, Alarm, and Camera. The main content area is titled 'Access Card' and contains the following sections:

- Open Door By DTMF Code:** 'Active' is set to 'Enabled' and 'Door 1' is set to '1'.
- Identify Door Phone:** An 'Identify' button and a 'Submit' button are present.
- Access Card:** 'Door opening method' is set to 'Password'. There is a 'Search By Name' input field with 'Search' and 'Cancel' buttons.

Index	Name	Password	Type	Door Number	Register Time