



**Dual button  
SIP Video Door Phone  
User Manual**

VDP SIP Door Phone User Manual .....	4
1 Overview .....	4
1.1 Introduction .....	4
1.2 Feature .....	4
1.3 Hardware Introduction .....	5
2 Installation .....	8
2.1 Check the contents of the package.....	9
2.2 Installation Guide .....	9
3 Feature .....	9
3.1 Dial .....	9
3.1.1 One touch dial : .....	9
3.1.2 Number dialing: .....	10
3.2 Swipe .....	10
3.3 Enter the password to open the door .....	11
3.4 DTMF Open Door .....	12
4 Web configuration .....	12
4.1 Status->Basic .....	13
4.2 Account .....	14
4.2.1 Account->Basic .....	14
4.2.2 Account-Advanced .....	15
4.2.3 Codecs .....	17
4.3 Network .....	18
4.3.1 Network Basic .....	18
4.3.2 TR069.....	19
4.3.3 SNMP.....	20
4.3.4 NMS.....	21
4.3.5 VLAN&QoS .....	22
4.3.6 802.1X.....	22
4.3.7 VPN.....	23
4.3.8 Diagnosis .....	24
4.4 Door Phone .....	25
4.4.1 Basic .....	25
4.4.2 Time&Date .....	27
4.4.3 Call Feature .....	28
4.4.4 Voice .....	29
4.4.5 Ringtones .....	30
4.4.6 Dial Plan .....	31
4.4.7 Action URL .....	33
4.4.8 Multicast .....	33
4.4.9 Intercom .....	34
4.4.10 Door Lock .....	35
4.4.11 Access .....	36
4.4.12 Alarm.....	37
4.4.13 Camera .....	38
4.5 PhoneBook .....	39
4.5.1 Local Book .....	39
4.5.2 Remote Book .....	40

4.5.3 BroadSoft.....	41
4.5.4 Call History.....	42
4.6 Maintenance.....	42
4.6.1 Upgrade.....	42
4.6.2 Auto Provision.....	43
4.6.3 System Log.....	44
	44
4.6.4 Network Capture.....	44
4.6.5 Configuration.....	45
4.6.6 PnP.....	45
4.6.7 Call Event.....	46
4.6.8 Reboot.....	46
4.6.9 Door Log.....	47
4.7 Security.....	48
4.7.1 Security Basic.....	48
4.7.1 Security Advanced.....	49
Appendix 1: Fault Resolution.....	50
Appendix 2: Time Zone.....	51

# VDP SIP Door Phone User Manual

## 1 Overview

### 1.1 Introduction

VDP is SIP access control phone with integrated HD camera and advanced audio system with echo cancellation. It supports H.264 video compression format and provides excellent video quality at 1080P video resolution. compatible with the standard SIP indoor monitor, you can talk to visitors at any time and view the video through the access control camera.

VDP provides users with keyless control and convenient, supports a variety of ways to open the door without keys. As long as it is an electronic door lock, it can be opened remotely. It can ideally control communication and security through the network, and can be well applied in areas such as commerce, institutions and residences.

### 1.2 Feature

- Video Function
  - 3 million pixel color CMOS camera
  - Maximum image transmission rate: 1080P -25fps
  - Video codec: H.264
  - Resolution: up to 1920 x 1080
  - Viewing angle: 80 ° (height), 60 ° (width)
  - Minimum brightness: 0.1lux
- Access Control
  - Access control unlock: DTMF, unlock code
  - SIP Door phone function
  - Full two-way
  - Auto answer by default
  - Remote control via URL / URI
  - Speed dial
- ManagementFunction
  - Automatic configuration: FTP/TFTP/HTTP/HTTPS/PNP
  - Configuration via HTTP / HTTPS web
  - SNMP/TR069 , NMS cloud management
  - Time synchronization service / Daylight saving time
  - Network upgrade firmware
  - System log
  - Configuration backup / restore
- Audio Function
  - HD audio
  - Two-way audio streaming
  - Wideband codec: G.722
  - Narrowband codec :PCMA, PCMU, G.729, G723\_53, G723\_63, G726\_32
  - Echo cancellation of G.168
  - Voice Activity Detection (VAD)
  - Comfort noise generator (CNG)

- Built-in micro speaker
- Acoustic echo cancellation audio output
- Protocol and network
- SIPv1 (RFC 2543) 、 v2 (RFC 3261)
- SIP based on TLS、 SRTP
- RTSP
- IPv4/IPv6
- TCP/UDP
- RTP/RTCP、 RFC 2198、 RFC 1889
- HTTP/HTTPS/FTP/TFTP
- ARP/RARP/ICMP/NTP
- DNS SRV/A Query/NATPR
- Primary and secondary DNS server
- Private network penetration protocol, session timer
- 802.1p/q、 DSCP、 802.1X
- DHCP/Static/PPPoE
- DTMF mode: In-Band、 RFC 2833、 SIP INFO

## 1.3 Hardware Introduction

- Front view and keyboard description

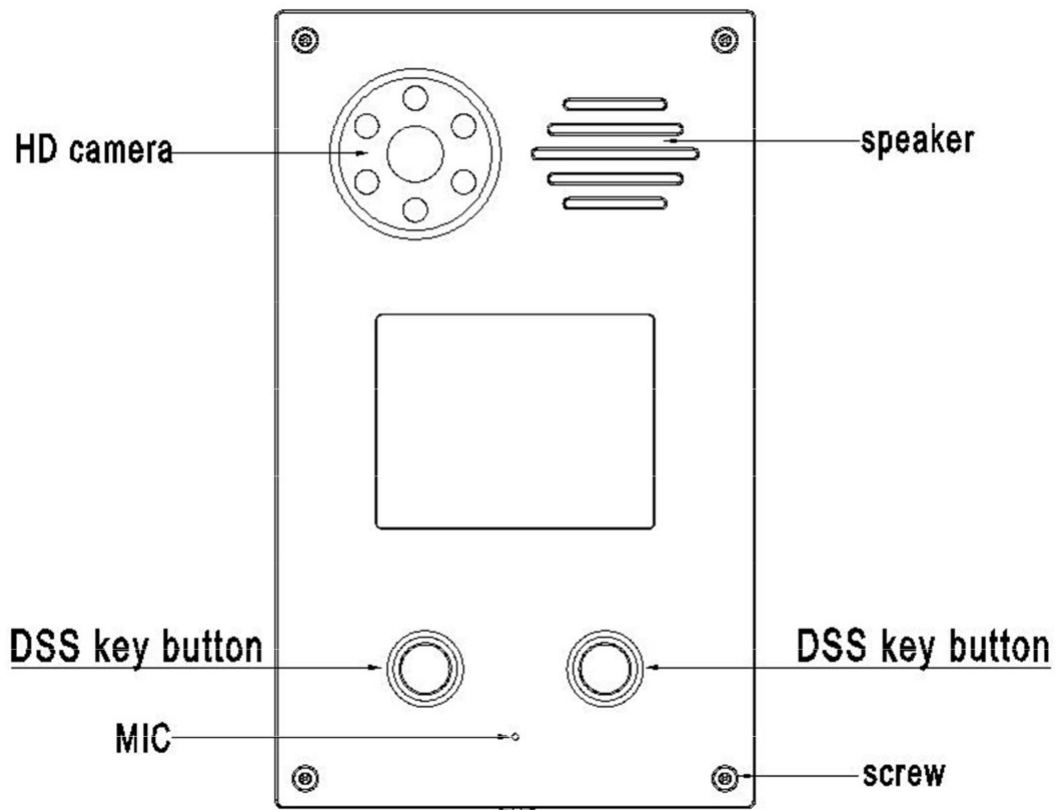

\*

Camera: 1080p HD camera

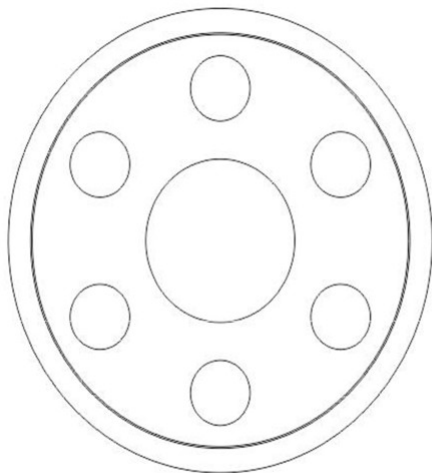

- Rear view and panel description

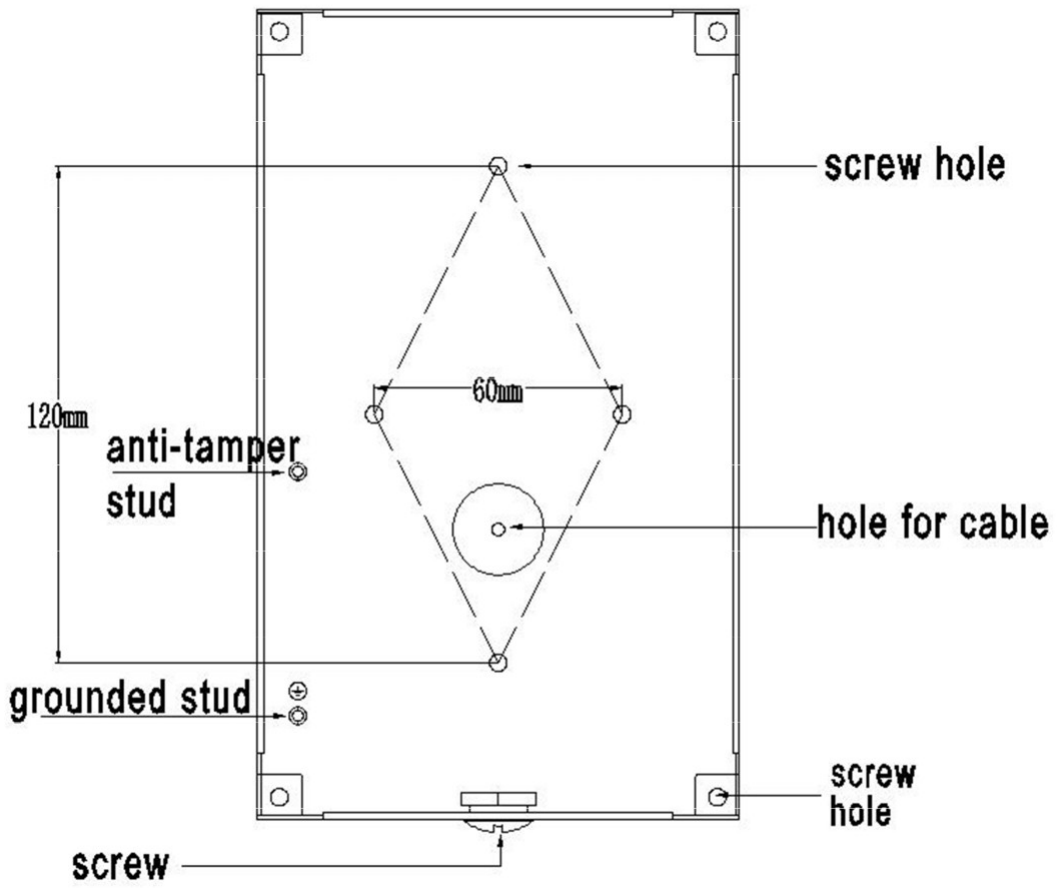
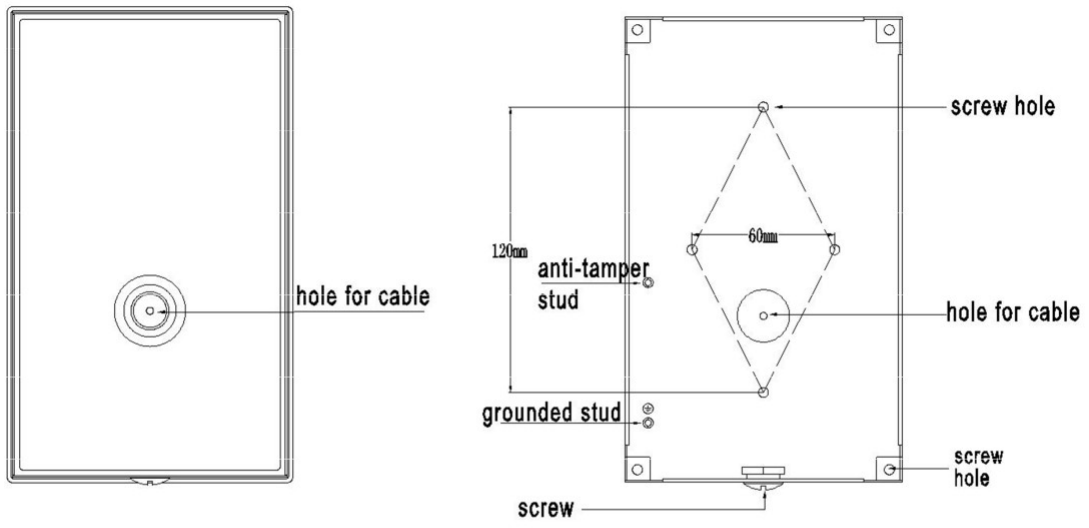

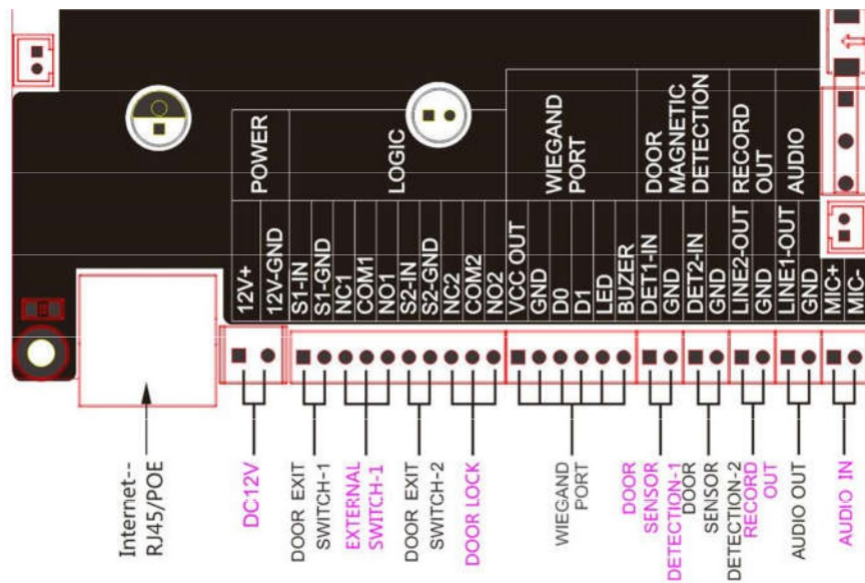

\*

Power Adapter	DC 12V/1A power adapter connector
Internet	LAN port for network connection, 10 / 100M, RJ45 Interface,POE
Door EXIT SWITCH	To connect exit switch button
EXTERNAL SWITCH/DOOR LOCK	To connect magnetic lock
WIEGAND PORT	To connect external wiegand reader
DOOR SENSOR DETECTION	To detect the lock close/open
RECORD OUT	To connect recorder
AUDIO OUT	To connect speaker
AUDIO IN	To connect MIC



## 2 Installation

### 2.1 Check the contents of the package

Please refer to the packing list below to check the integrity of the packing.

\*

VDP SIP Door phone	1
Screw accessories package	1
Quick Guide	1

### 2.2 Installation Guide

#### Step 1 : Power on

The equipment needs external 12V DC power supply, Connect the supplied power adapter to the power port , and then plug the adapter into an available power outlet(If you don't have external 12V DC power supply, you can also use POE network cable). Until the button light is on and two beeps are heard.

Please use 12V DC 1A power adapter, or POE

#### Step 2: Connect Network

Connect one end of the Ethernet cable to the Internet port on the back of the VDP, and the other end to the wall network jack.

#### Step 3: Connect to computer

Press DSS1 key continuously for 10 seconds, and the device will broadcast its IP address.

#### Step 4: Configure the device

Start a web browser on the computer and enter the phone's IP address into the address bar. If the address is correct, a login screen will appear, enter the user name and password to log in to the web console to log in to the phone webpage.

Default account & password: admin/admin.

DP series SIP doorphone support DHCP/Static/PPPoE to search the IP address, Press DSS1 key continuously for 10 seconds, and the device will broadcast its IP address.

## 3 Feature

### 3.1 Dial

You can use the following three methods to make calls:

#### 3.1.1 One touch dial :

Click "Door Phone-Call feature" in the left navigation bar to enter the phone configuration, In the "Call Button Selection" item, you can set 2 call button, each button can set 4 commonly used indoor unit numbers, of which "Call Button Day 1 ~ 3" is the outgoing number during the day, Call Button Night is the outgoing number at night, the number is a one-touch dial button The dialed number (VDP phone can directly press the "Dial" button to dial the number); Round Robin Time Out is the time-out period . If a number times out and does not answer, the door phone will automatically dial the next number (Call Button Night number at night); In Day Night Setting, you can configure the day and night start time to determine the number dialed at the current time;

Click on Submit Button.

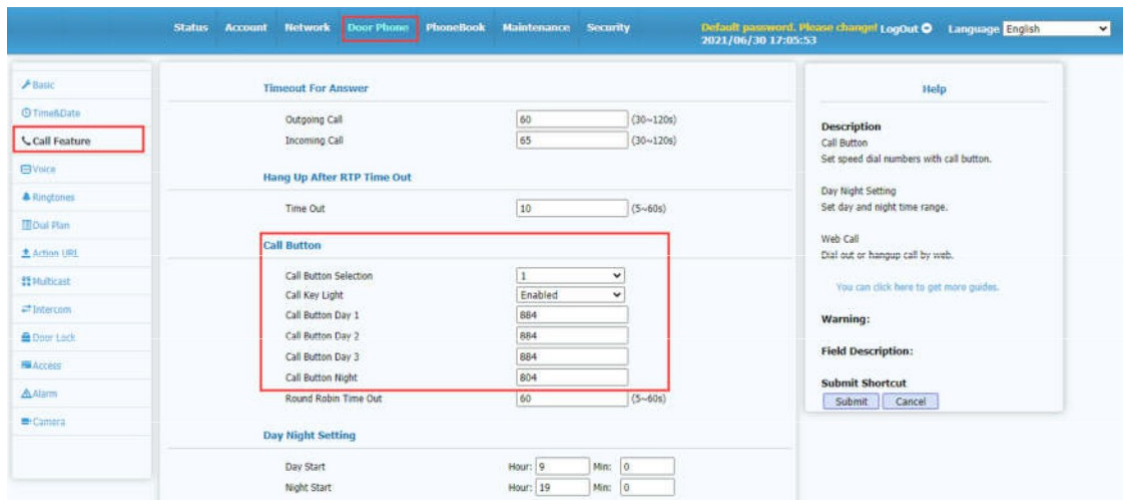

### 3.1.2 Number dialing:

Enter an existing SIP / IP account and press the dial key.

## 3.2 Swipe

VDP does not have a built-in swipe card module, so it needs to be connected with a card reader which supports Wiegand protocol.

Click "Door Phone - Access", in the "Access Card" items, swipe a new card to the VDP, then press "F5" refresh the web GUI, RFID card number will auto appeared, then click "add" item.

Use the corresponding door card to open the door by swiping the card. With one beep sound door open.

Status Account Network **Door Phone** PhoneBook Maintenance Security Default password. Please change! LogOut Language: English

2021/06/30 17:17:28

Basic  
 Time&Date  
 Call Feature  
 Voice  
 Ringtones  
 Dial Plan  
 Action URL  
 Multicast  
 Intercom  
 Door Lock  
**Access**  
 Alarm  
 Camera

**Open Door By DTMF Code**  
 Active: Enabled  
 Door 1: 1  
 Door 2: 2

**Identify Door Phone**  
 Identify: [Submit]

**Access Card**  
 Card Type: RFID  
 Search By Room Number: [Search] [Cancel]

Index	Room Number	RFID	Type	Door Number	Register Time	Period
4		014cc513	normal	182	2021-06-25 11:45:31	--
3	2	10657e9c	normal	182	2021-06-24 07:14:31	--
2	1	b01b949c	admin	182	2021-06-24 06:55:10	--
1	1	c25e8056	normal	182	2021-06-24 01:57:35	--

Page 1 [Prev] [Next] [Delete] [Delete All]

**Card Register**  
 Door Number: 182  
 Room Number: [ ]  
 RFID: [ ]  
 Hear Tone: [Internal]

**Help**  
**Description**  
 Open Door By DTMF Code  
 Set DTMF code that used to open door by call remote end.  
 Identify Door Phone  
 Play beep tone to identify device.  
 Access Card  
 Access card management.  
 Open Door By HTTP  
 Open door via http request.  
 You can click here to get more guides.  
**Warning:**  
**Field Description:**  
**Submit Shortcut**  
 [Submit] [Cancel]

### 3.3 Enter the password to open the door

Click “Door Phone- Access”, in the “Access Card” items, select “password”

Status Account Network **Door Phone** PhoneBook Maintenance Security Default password. Please change! LogOut Language: English

2021/07/01 01:59:50

Basic  
 Time&Date  
 Call Feature  
 Voice  
 Ringtones  
 Dial Plan  
 Action URL  
 Multicast  
 Intercom  
 Door Lock  
**Access**  
 Alarm  
 Camera

**Open Door By DTMF Code**  
 Active: Enabled  
 Door 1: 1  
 Door 2: 0

**Identify Door Phone**  
 Identify: [Submit]

**Access Card**  
 Card Type: Password  
 Search By Room Number: [Search] [Cancel]

Index	Room Number	Password	Type	Door Number	Register Time	Period
1		*****	normal	182	2021-06-25 08:27:08	--

Page 1 [Prev] [Next] [Delete] [Delete All]

**Card Register**  
 Door Number: 182  
 Room Number: [ ]  
 Password: [ ] (4~15)

**Help**  
**Description**  
 Open Door By DTMF Code  
 Set DTMF code that used to open door by call remote end.  
 Identify Door Phone  
 Play beep tone to identify device.  
 Access Card  
 Access card management.  
 Open Door By HTTP  
 Open door via http request.  
 You can click here to get more guides.  
**Warning:**  
**Field Description:**  
**Submit Shortcut**  
 [Submit] [Cancel]

### 3.4 DTMF Open Door

Click “Door Phone- Access”, in “Open Door By DTMF Code”, click “Enabled”to configure DTMF Code to open door

After setting, click Submit button.

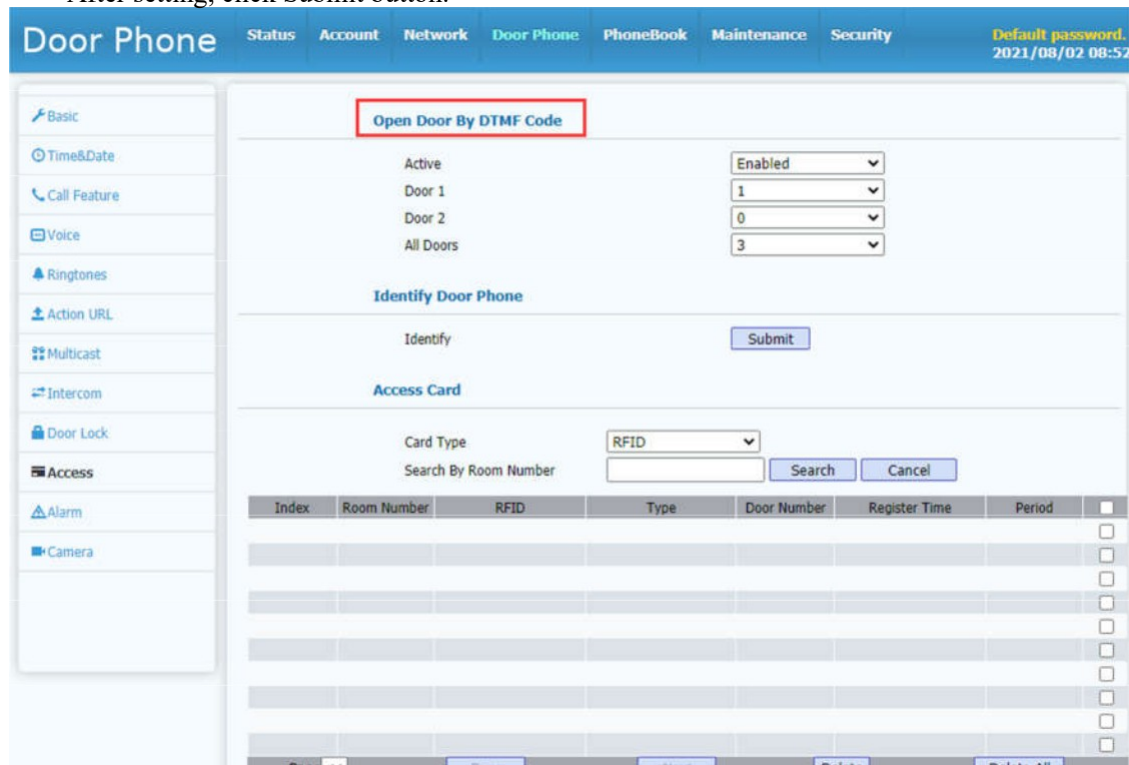

VDP supports 3 types DTMF: Inband、RFC 2833、SIP INFO

## 4 Web configuration

Press DSS1 key continuously for 10 seconds, and the device will broadcast its IP address.

Open the browser on the PC, enter the phone IP address, such as <http://172.31.2.229>, enter the user name and password to log in to the phone web interface, the default user name and password: admin / admin.

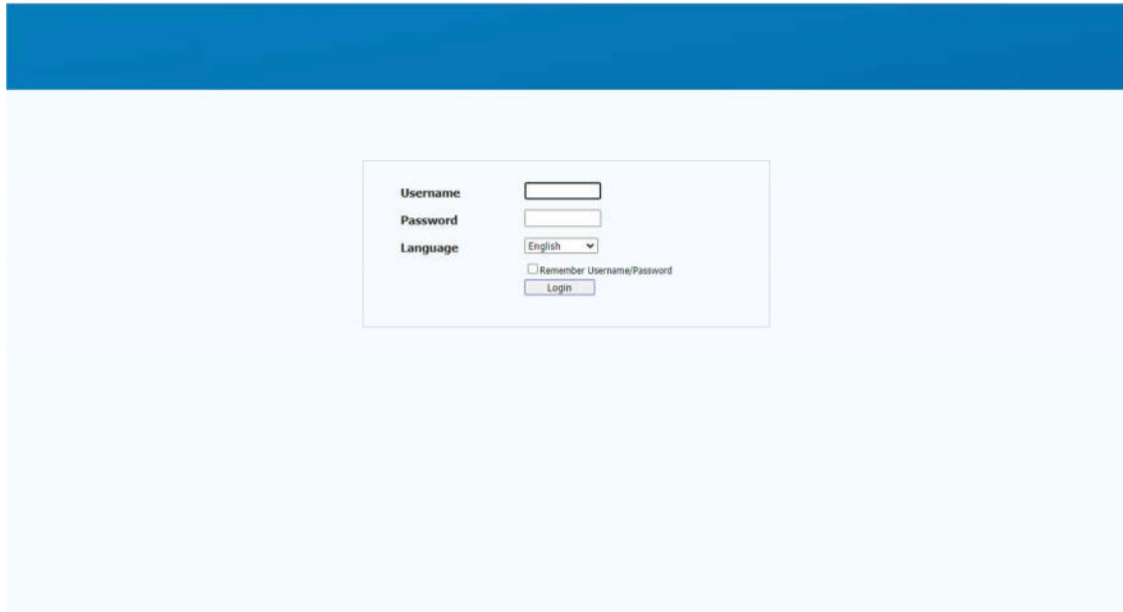

## 4.1 Status->Basic

Basically the Status in Web menu showing the Product information, Network information, you can roughly know the product model, network connection & account registration, As shown below,

Product Information	
Model	DP88
MAC Address	60-C7-A3-10-37-31
SN	1021-3344-5566-7788
Firmware Version	2.85.6.0.2
Hardware Version	88.2.0.0.0.5.0
Uptime	0 day 0 h 30 min

Network Information	
LAN Mode (IPv4/IPv6)	IPv4 & IPv6

IPv4	
LAN Port Type	DHCP
LAN IP Address	172.25.1.17
LAN Subnet Mask	255.255.255.0
LAN Gateway	172.25.1.1
LAN DNS1	172.16.0.1
LAN DNS2	114.114.114.114

IPv6	
LAN IPv6 Port Type	DHCP
LAN IPv6 Address	
LAN IPv6 Gateway	
LAN IPv6 DNS1	
LAN IPv6 DNS2	

Other	
LAN Link Status	Connected
Primary NTP	0.pool.ntp.org
Secondary NTP	1.pool.ntp.org
VPN Status	Disabled
NMS Status	Disabled

\*

**Product Information** Display the basic information of the settings, such as Model, MAC Address (physical address of the IP device), Firmware Version, and Hardware Version.

**Network**

**Information**

- Display the set network status, Ex:LAN Port Type (DHCP/Static

- IP/PPPoE) 、 LAN Link Status、 LAN IP Address、 LAN Subnet Mask、
- LAN Gateway、 LAN DNS1、 LAN DNS2、 Primary NTP and Secondary
- NTP (NTP server is used to automatically synchronize the time from
- the Internet) .

Account Information Display device account information and registration status (account user name, registration server address and registration result).

## 4.2 Account

The account in web GUI Include

1. Basic system information;
2. Advanced account display & configure;
3. Audio, video codec display & configure.

### 4.2.1 Account->Basic

The screenshot displays the 'SIP Account' configuration page in a web GUI. The page is organized into several sections:

- SIP Account:**
  - Status: Registered
  - Account: Account1: 7001
  - Active: Enabled
  - Display Name: 7001
  - Register Name: 7001
  - Username: 7001
  - Password: \*\*\*\*\*
- SIP Server 1:**
  - Server IP: 172.25.23.140
  - Port: 5060
  - Registration Expires: 1800 (30~65535s)
- SIP Server 2:**
  - Server IP: (empty)
  - Port: 5060
  - Registration Expires: 1800 (30~65535s)
- Outbound Proxy Server:**
  - Active: Disabled
  - Server IP: (empty)
  - Port: 5060
  - Backup Server IP: (empty)
  - Port: 5060
- Transport Type:**
  - Transport Type: UDP

The left sidebar contains navigation options: Basic, Advanced, and Audio Codecs. The top navigation bar includes: Status, Account, Network, Door Phone, PhoneBook, Maintenance, Security, and a default password field showing '2021/07/01 03:32'.

The screenshot shows a configuration window with two main sections: NAT and VPN. In the NAT section, there is a dropdown menu currently set to 'Disabled', a text input field for 'Stun Server Address', and a 'Port' field with the value '3478'. In the VPN section, there is a dropdown menu currently set to 'Enabled'. At the bottom of the window, there are two buttons: 'Submit' and 'Cancel'.

\*

SIP Account	<p>Display and configure basic account information:</p> <p><b>Status:</b> Display account registration results;</p> <p><b>Display Label:</b> The label displayed on the screen;</p> <p><b>Display Name:</b> Send to another caller for display;</p> <p><b>Register Name:</b> Assigned by SIP server provider;</p> <p><b>User Name:</b> Deploy SIP account by SIP server;</p> <p><b>Password:</b> Certification authorization while do the registration &amp; call.</p>
SIP Server 1	<p>Display and configure master server information:</p> <p><b>Server IP:</b> SIP server address can be a domain name or an IP address;</p> <p><b>Registration Period:</b> The IP phone will automatically re-register within the registration period;</p>
SIP Server 2	<p>Display and configure secondary server information:</p> <p>If registration secondary SIP server, the IP phone will go to both Primary/secondary SIP server together at the same time.</p> <p>If registration fails on the primary SIP server, the IP phone will go to the secondary SIP server for registration.</p> <p><b>Notice :</b> The secondary SIP server is used for backup, if the user environment does not have a backup SIP server, it can be left blank;</p>
Outbound Proxy Server	<p>Display and configure proxy server settings.</p> <p>The proxy server is used to receive all activated request messages and route them to the designated SIP server.</p> <p><b>Notice:</b> If configured, If a proxy server is configured, all SIP request messages from IP phones will be sent to the proxy server forcibly. Display</p>
Transport Type	<p>and configure the transmission type of SIP messages: <b>UDP:</b> UDP is an unreliable but very effective transport layer protocol; <b>TCP:</b> Reliable but less efficient transport layer protocol; <b>TLS:</b> Safe and reliable transport layer protocol; <b>DNS-SRV:</b> Is a type of DNS record used to specify the server address; Display and configure NAT (Network Address</p>
NAT	<p>Translator): <b>STUN:</b> Simple traversal of UDP on NATS is the solution to all NAT problems.</p>
VPN Preferred	<p><b>Notice:</b> By default, NAT is disabled.</p> <p>Device can send or receive command and media data via VPN port if device enable the VPN.</p> <p><b>Notice:</b> By default, VPN is enabled.</p>

## 4.2.2 Account-Advanced

This advanced web GUI can select account and also can do configure operation, such like DTMF, CALL, NAT, KEEP ALIVE, see as below.

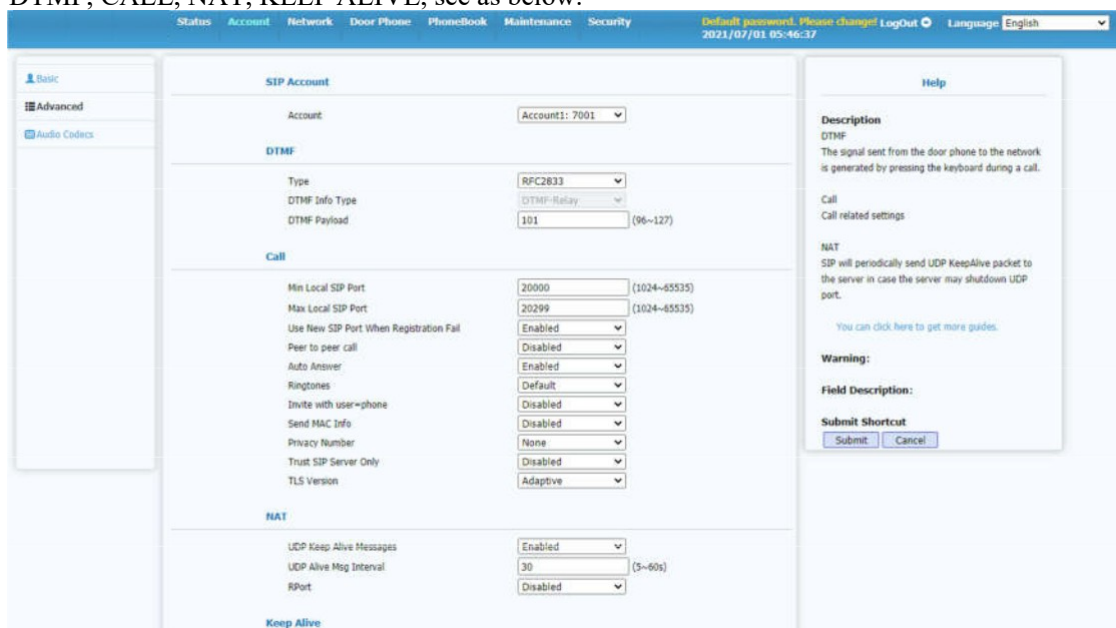

\*

SIP account	Display the current account settings or select the account to display.
DTMF	Display the DTMF type (Inband、RFC 2833、Info) 、DTMF info type (DTMF-Relay、DTMF、Telephone-Event) 、DTMF payload (96~127) 。
Call	<p>Display call configure items, include local SIP port range(It will prompt when set port range occupied, Use New SIP Port When Registration Fail, Peer to peer call, Auto Answer, Ringtones, Invite with user=phone, Send MAC Info, Privacy Number, Trust SIP Server Only, TLS Version)</p> <p><b>Min Local SIP Port:</b> cannot be empty, default 20000,Only integers within (1024~65535) can be filled。</p> <p><b>Max Local SIP Port:</b> cannot be empty, default 20299,Only integers within (1024~65535) can be filled。</p> <p><b>Use New SIP Port When Registration Fail:</b> default enable.</p> <p><b>Peer to peer call:</b> Enable device call from server address without pre-registration.</p> <p><b>Auto Answer:</b> Enable device auto answer when call in, default enable.</p> <p><b>Ringtones:</b> Enable to choose phone ringtone.</p> <p><b>Invite with user=phone:</b> Enable the call msg device send include user=phone.</p> <p><b>Send MAC Info:</b> Enable device bring its MAC address when do the registration.</p> <p><b>Privacy Number:</b> default empty, (empty、ID、PAI) available.</p> <p><b>Trust SIP Server Only:</b> Device only receive SIP command from trust SIP server.</p>



NAT	<p><b>TLS version:</b> Enable device do the configure for TLS version, default Adaptive (Adaptive、TLS 1.0、TLS 1.1、TLS 1.2)</p> <p>IP phones can send valid data packets that keep the communication port open to the NAT server;</p> <p><b>UDP Keep Alive Messages:</b> options, default Enabled, can choose (Enabled and Disabled);</p> <p><b>UDP Alive Msg Interval:</b> When UDP Keep Alive Messages is Enabled, it cannot be empty, the default is 30, [1,63] characters, only integers within [5,60] can be filled; when UDP Keep Alive Messages is Disabled, this item is not available Edit status</p> <p><b>RPort:</b> optiond, default Disabled, can choose (Enabled and Disabled);</p>
Others	<p><b>Sync Time from SIP Server:</b> Enable device sync time via SIP server, default Disabled.</p> <p><b>Use IPv6 Stateless Address:</b> Enable use IPv6 Stateless Address when registration, default Enabled, (Enabled、Disabled)。</p> <p><b>SIP Registration Retry Timer:</b> The interval time when re- registration after configure SIP fail, default is 100 second, (1~1800 second)。</p> <p><b>Unregister When Reboot:</b> Enable device logout after device reboot, default Disable, (Enabled、Disabled)。</p>

### 4.2.3 Codecs

Codecs display & configure supported audio codecs, PTime, Codecs Payload, see as below,

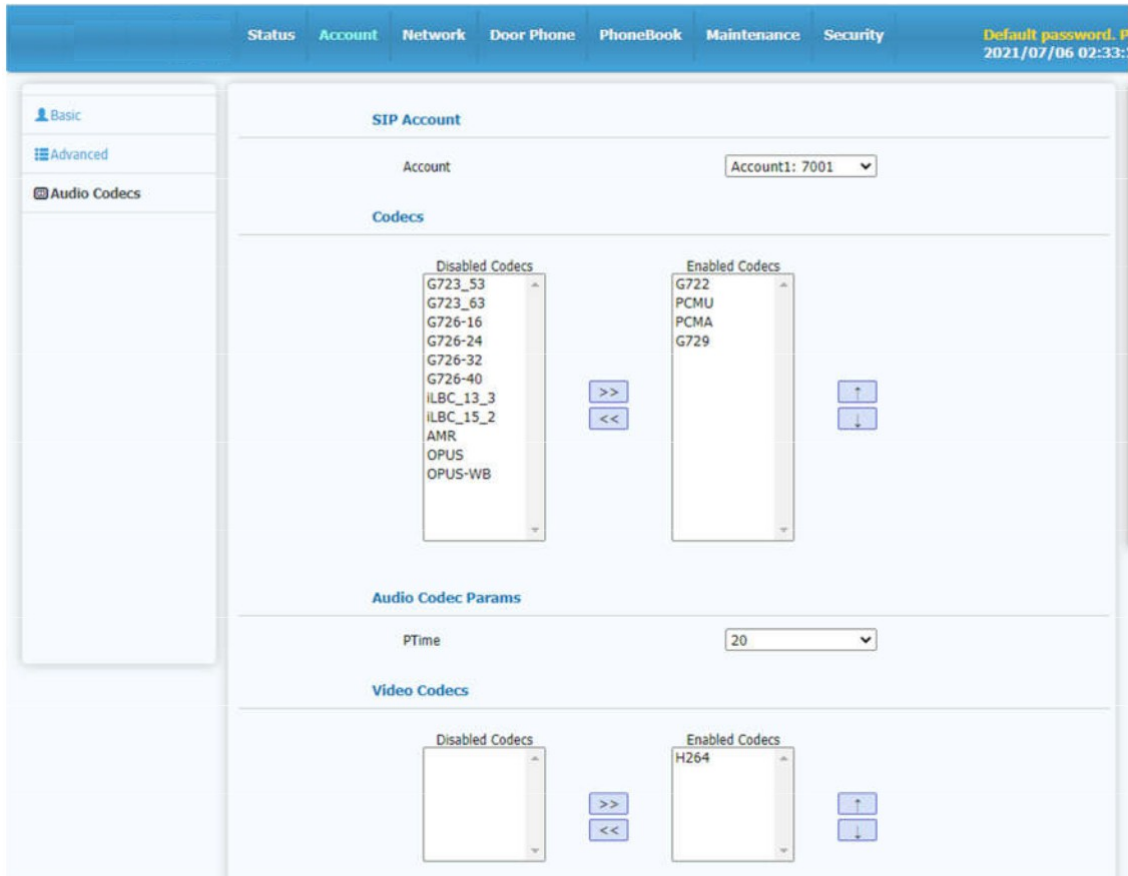

\*

Audio Codecs	Display and configure a list of available / unavailable codecs. A codec refers to a codec used to convert analog signals into digital signals or digital signals into analog signals. Familiar codecs are PCMU (G711U), PCMA (G711A), G722 (broadband codec), G729, G723_53, G723_63, G726_16, G726_24, G726_32, G726_40.
Audio Codec Params	PTime : Default 20ms, (Disabled、10、20、30、40、50、60)
Video Codecs	Currently only support H.264.
Video Codec Params	Codecs Payload: Default 96, (96~127)。

## 4.3 Network

Web GUI mainly display & configuration, include devices network IP address get, TR069 Network management, NMS Cloude management service, VLAN & Qos etc.

### 4.3.1 Network Basic

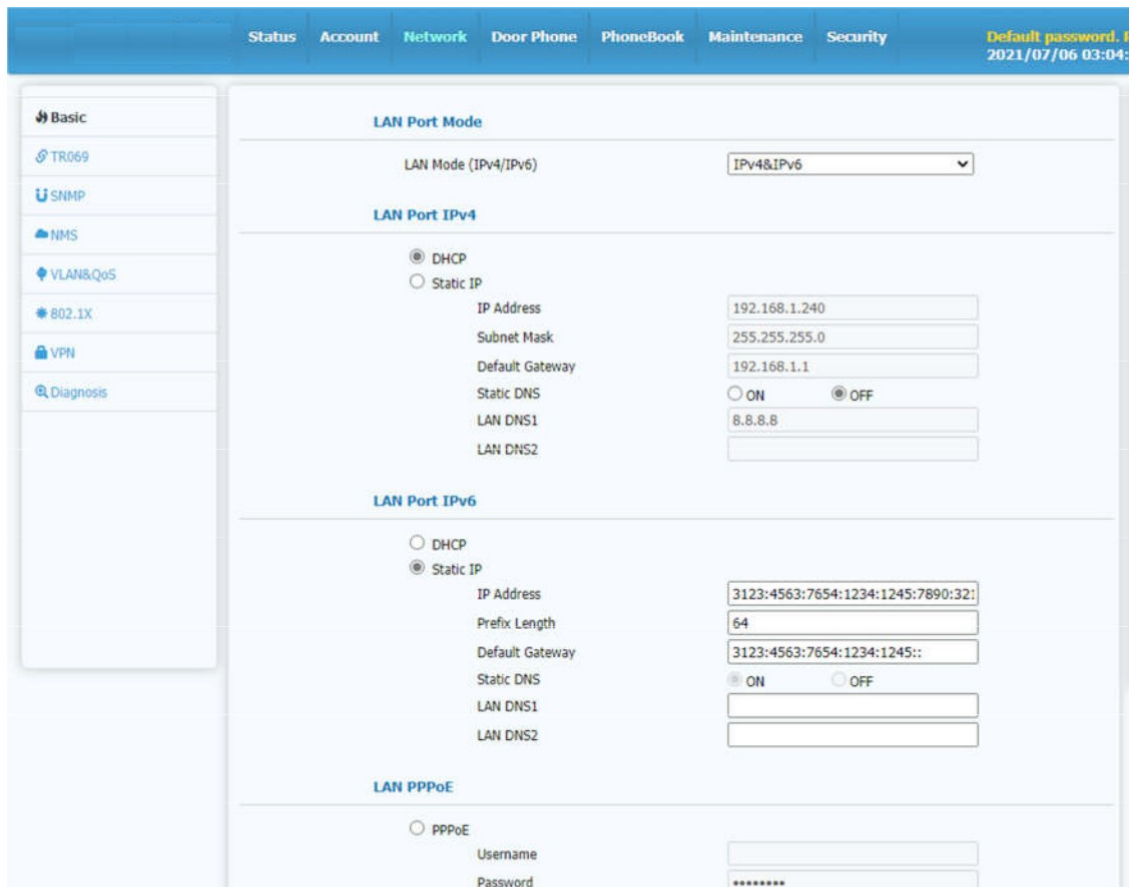

\*

- LAN Port Mode                    Configure LAN Port mode, Default is IPv4, (IPv4、IPv6、IPv4&IPv6) .
- LAN Port IPv4                    Configure the way LAN Port get IP address with IPv4, default is DHCP,(DHCP、Static IP)
- LAN Port IPv6                    Configure the way LAN Port get IP address with IPv6, default is DHCP,(DHCP、Static IP)
- LAN Port PPPoE                    Configure the PPPoE's verification's password & password via LAN Port.
- Speed and Duplex                    Configure the LAN Port connection speed, Default is

### 4.3.2 TR069

TR069 mainly display & configure TR069 parameters, TR-069 (Technical Report - 069) is a remote control terminal communication protocol based on CWMP(CPE WAN Management Protocol), see as below,

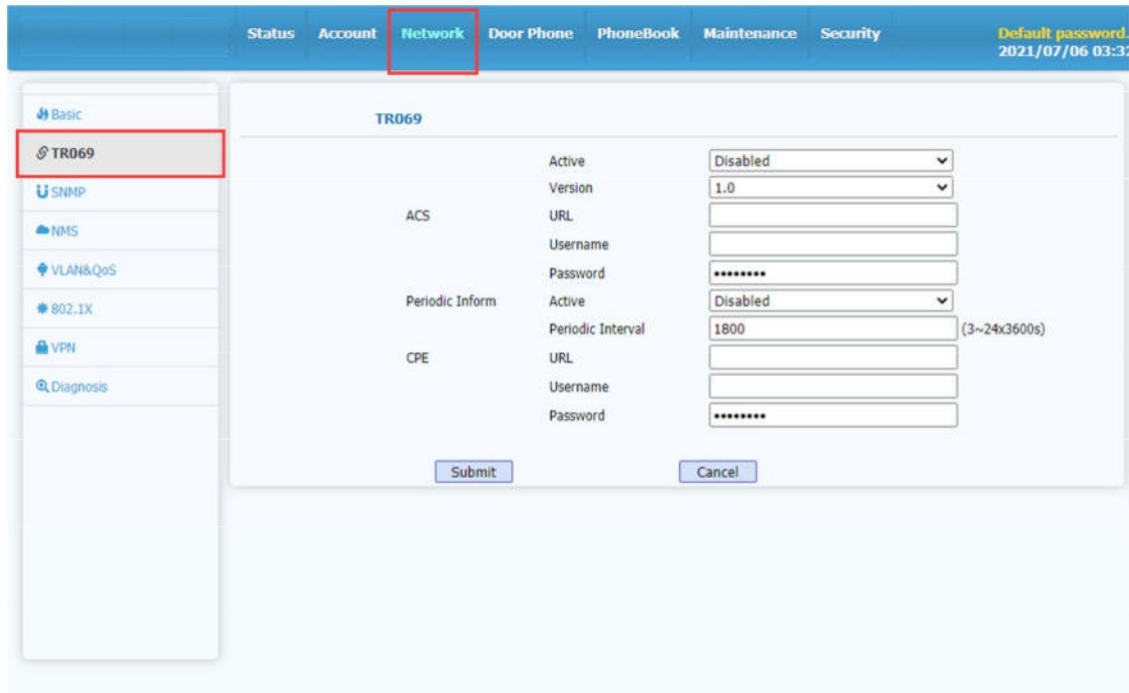

\*

Active	To enable or disable TR069 feature.
Version	To select supported TR069 version (version 1.0 or 1.1).
ACS URL	ACS: ACS is short for Auto configuration servers as server side.
Username/Password	Configure Username/Password when connect to the ACS server.
Periodic Inform Active	To enable periodically inform.
Periodic Interval	To configure interval for periodic inform, default 1800 seconds,(3~24x3600s)
CPE URL	CPE is short for Customer-premise equipment as client side devices, mainly use for service & client dual-way verification.
CPE Username/Password	Configure Username/Password when server verificate to CPE side.

### 4.3.3 SNMP

SNMP is a simple network management protocol, To display and configure SNMP settings, see as below.

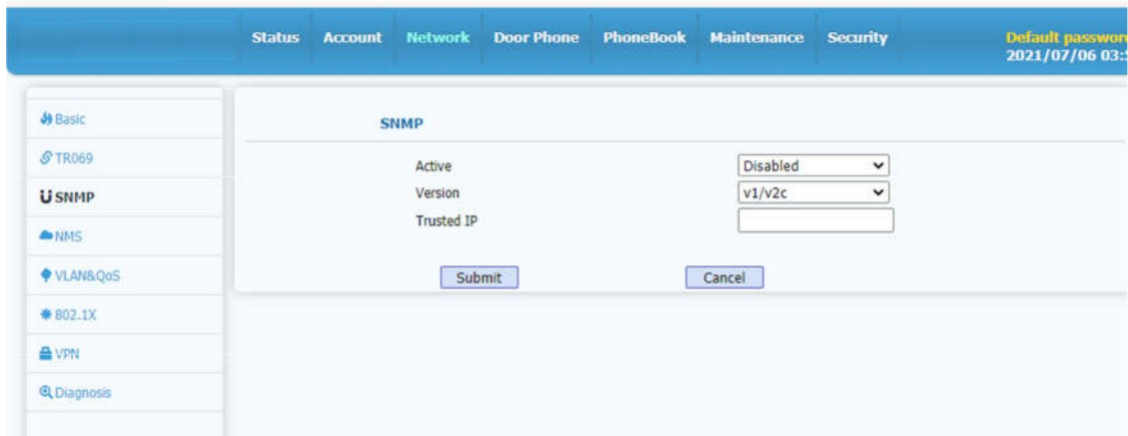

\*

Active	To enable or disable SNMP feature.
Version	To select supported SNMP version, default is v1/v2 ,(v1/v2、 v3)
Trusted IP	Configure SNMPserver IP address

### 4.3.4 NMS

NMS is a private cloud network management system based on HTTP protocol, NMS support online setting, remote control, auto deploy & update for the terminal, see as below,

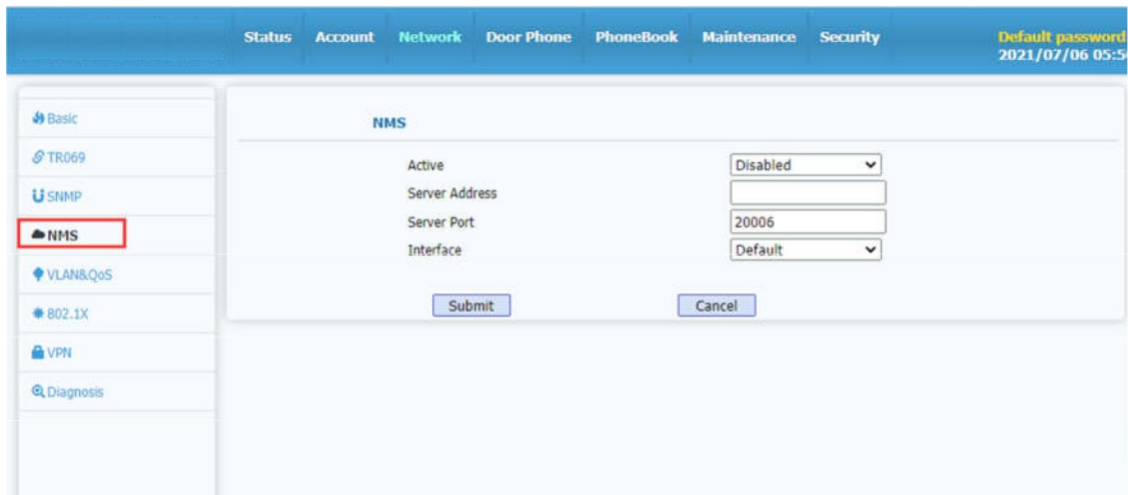

\*

NMS Active	To enable or disable NMS feature.
Server Address	To configure cloud network server address or domain name.
Server Port	To configure cloud network server port.
Interface	To configure terminal & cloud network server port name, (default, PPPoE,tun0, tap0 is optional)

### 4.3.5 VLAN&QoS

VLAN&QoS is to display & configure VLAN parameter on LAN port, and then set SIP command & QoS of Audio, see as below,

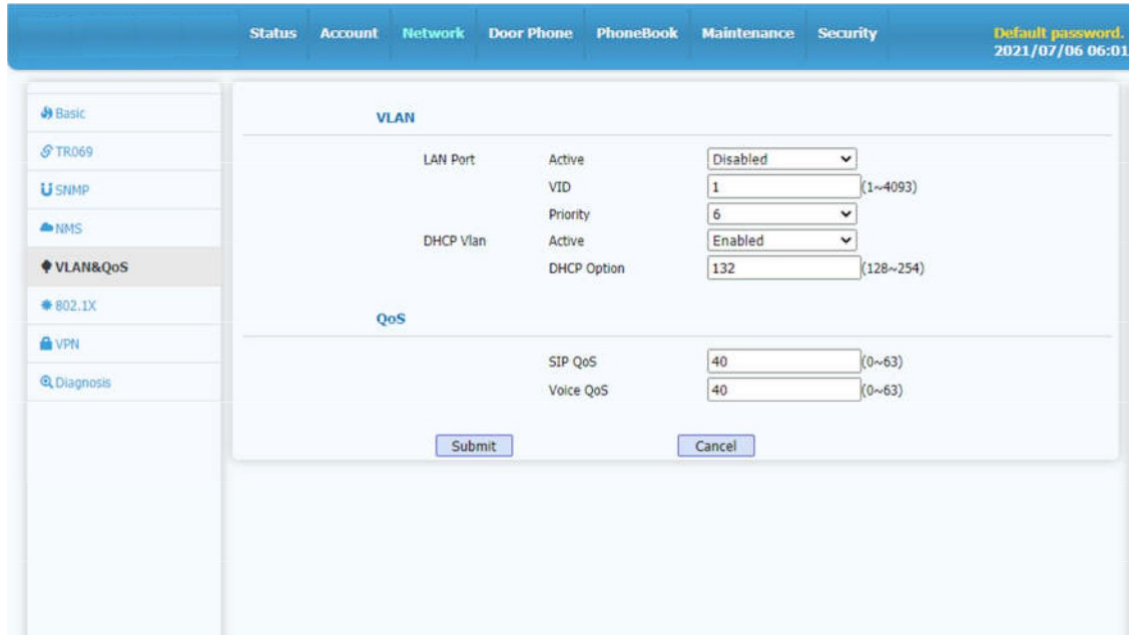

\*

VLAN LAN Port	To configure VLAN property of LAN port: <b>Active:</b> To enable or disable VLAN feature. <b>VID:</b> To configure VLAN id for designated port. (1~4093) 。 <b>Priority:</b> To select VLAN priority for designated port.. (0~7) 。
VLAN DHCP Option	To configure the VLAN property when DHCP receive the server address. <b>Active:</b> To Enable or disable the VLAN property when DHCP receive the server address. <b>DHCP option:</b> To configure DHCP receive VLAN setting, (128~254) 。
QoS	To display and configure QoS settings. <b>SIP QoS:</b> To configure QoS value for all SIP message. <b>Voice QoS:</b> To configure QoS value for all audio stream(RTP streams).

### 4.3.6 802.1X

802.1X is to display and configure 802.1x settings. 802.1x is a verification framework, support multi-verification protocol, currently mainly protocol like EAP-MD5、EAP-TLS、EAP-TTLS、EAP-PEAP & EAP-FAST etc, see as below,

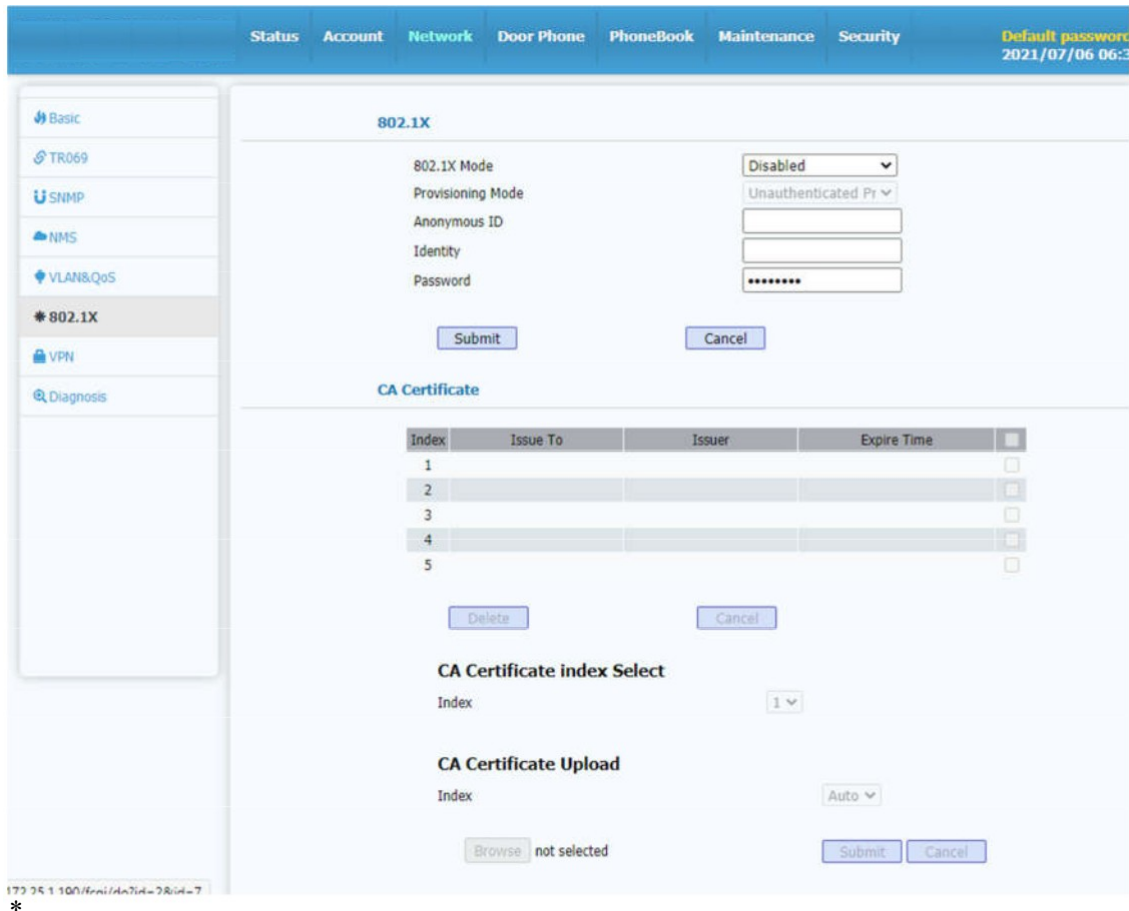

802.1x

To display and configure 802.1x settings.

**802.1x Mode:** To enable or disable 802.1x, default is disable. (EAP-MD5、EAP-TLS、EAP-TTLS、EAP-TTLS/EAP-MSCHAPv2、EAP-TTLS/EAP-GTC、EAP-PEAP/MSCHAPv2、EAP-PEAP/GTC、EAP-FAST) .

**Provisioning Mode:** When verification protocol is EAP-FAST, can identify whether use identity verification or without identity verification through configure Provisioning.

**Anonymous ID:** To configure anonymous ID to replace actual user ID makes user more secure.

**Username/password:** insert username/password when configure.

CA Certificate

To provide CA Certificate index display & upload feature.

Device Certificate

To provide Device Certificate index display & upload feature.

### 4.3.7 VPN

To display and configure VPN setting, include enable or disable Open VPN feature, and provide VPN certificate upload, currently support Open VPN features.

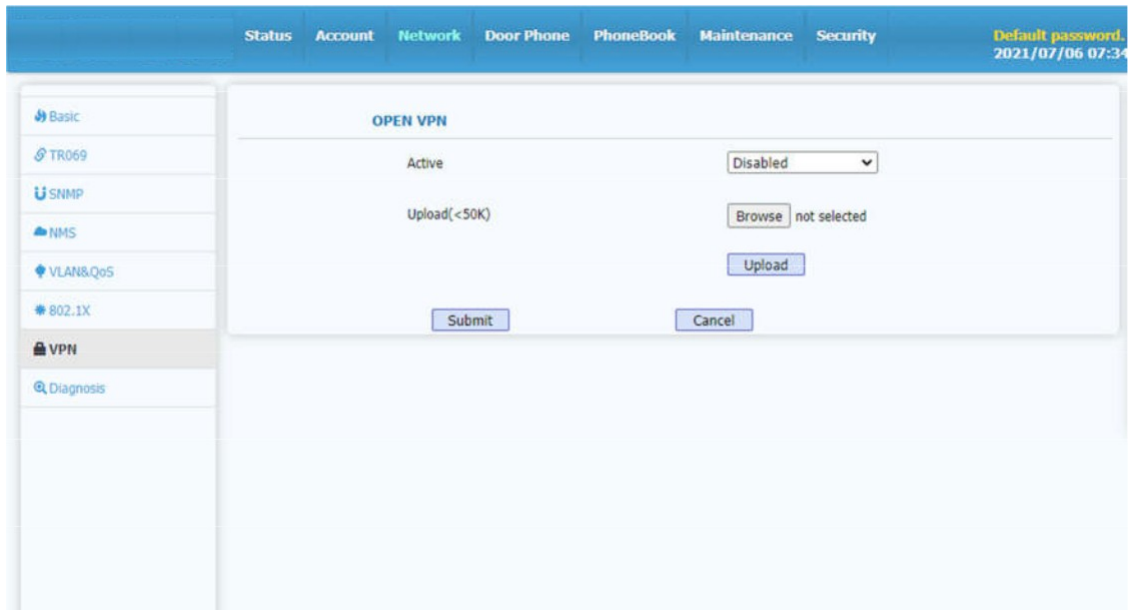

\*

---

Active	Enable or disable Open VPN。
upload	To upload VPN client configuration file which is used to connect to VPN server.

### 4.3.8 Diagnosis

Diagnosis mainly support network diagnosis tools, like ping & trace route feature, currently provide ping feature, will complete other functions in next version, see as below,



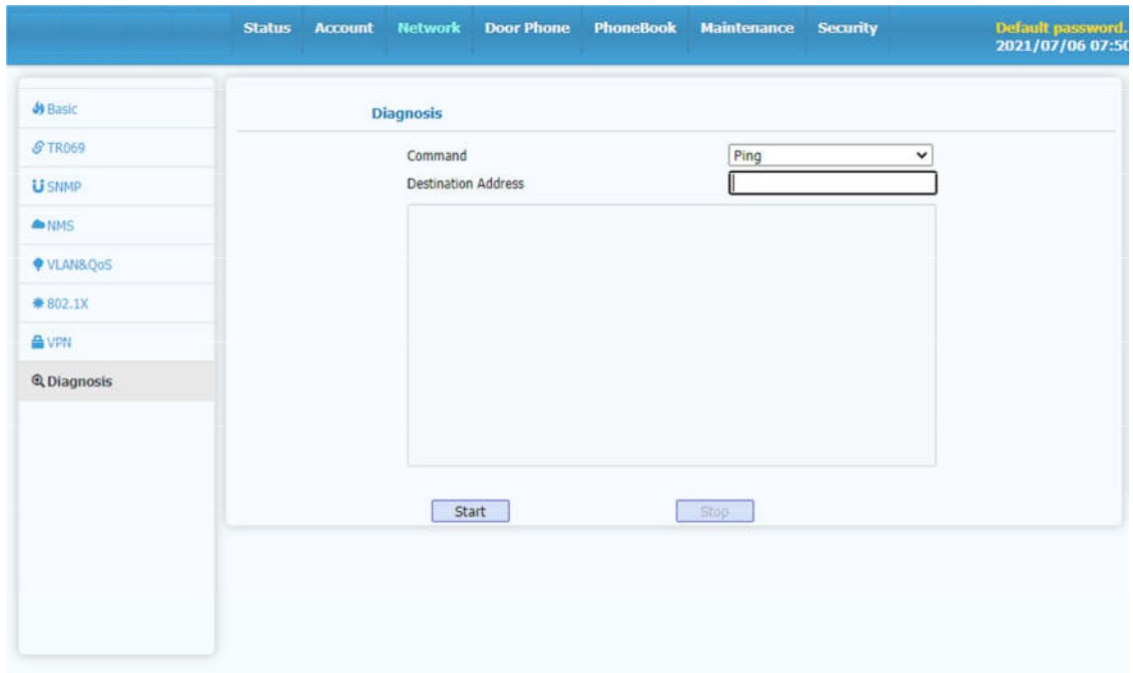

## 4.4 Door Phone

Door Phone Items display and configure door phone parameters, include device languages, device switch parameter, RFID parameters, time & date configure, call configure, audio & ringtone configure etc...

### 4.4.1 Basic

Basic item display and configure device language, device access parameters, RFID parameters, see as below.

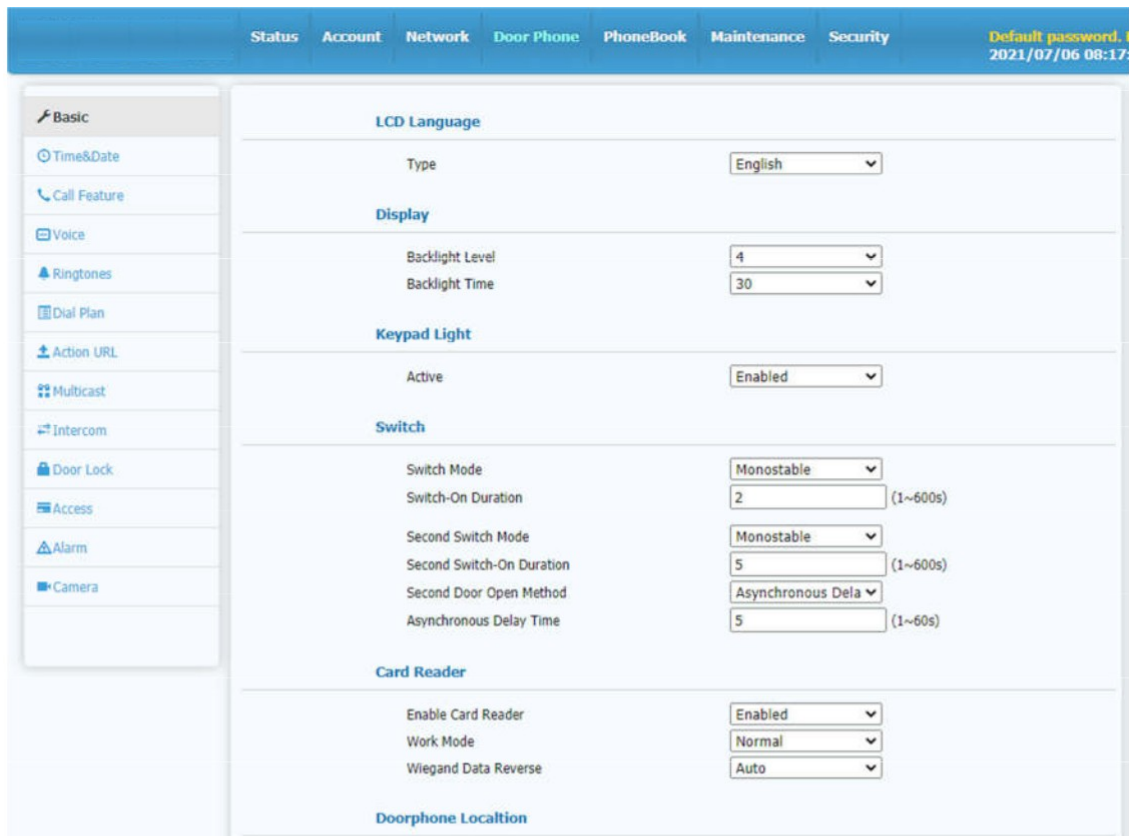

\*

LCD language	Default is simplified Chinese, (English,traditional Chinese optional)
Display	To configure LCD backlight level and backlight time. <b>Backlight level:</b> (level from 1~5) . <b>Backlight time:</b> default is always on, ( Always on, 15, 30, 60, 120, 300, 600, 1800, 3600 )
Keypad light	Default is auto, (Auto、 Enable、 disable) . when choose auto, it will enable on day, disable on light based on the time setting
Switch	To configure door phone switch and time. <b>Switch Mode:</b> configure switch mode, default Monostable, (Monostable, Bistable). Monostable mean door will auto close after several times; Bistable means door will close only after get a close signal(for example swipe to open, and then swipe again to close). <b>Switch-On Duration:</b> default 2s, ( 1~3600s ) 。 <b>Second Switch Mode:</b> same like first switch operation, default is Monostable, ( Monostable, Bistable optional ) 。 <b>Second Switch-On Duration:</b> same like first switch operation, default 2s. ( 1~3600s ) <b>Second Door Open Method:</b> Configure whether 2 <sup>nd</sup> door linkage with 1st door , default is independent, (Independent, Aynchronous relay) <b>Independent means :</b> after 1 <sup>st</sup> door open, 2 <sup>nd</sup> door need operation

independently to open. For example, swipe to open 1<sup>st</sup> door, and then swipe again to open 2<sup>nd</sup> door.  
 Aynchronous relay means swipe can open both 1<sup>st</sup> door & 2<sup>nd</sup> door, default time is 5s, (1-60s)

Card Reader	To configure RFID parameters <b>Enable Card Reader:</b> To Enable and disable Card reader, default is enable,(Enable, Disable). <b>Work Mode:</b> To configure card reader Work Mode, default is Normal, (Normal, Card Issuing, Card Revoking) .Normal means daily swipe card to open door; card issuing means to issue card to new card, door will not open on this mode; Card Issuing means to revoke registered card, door will not open on this mode. <b>Wiegand Data Reverse:</b> To enable or disable Wiegand data reverse feature to support external wiegand card reader. default is auto, (Auto, Enable, Disable)
Door Phone Location	To configure Doorphone address, Community Name, Building Number, Door Number

## 4.4.2 Time&Date

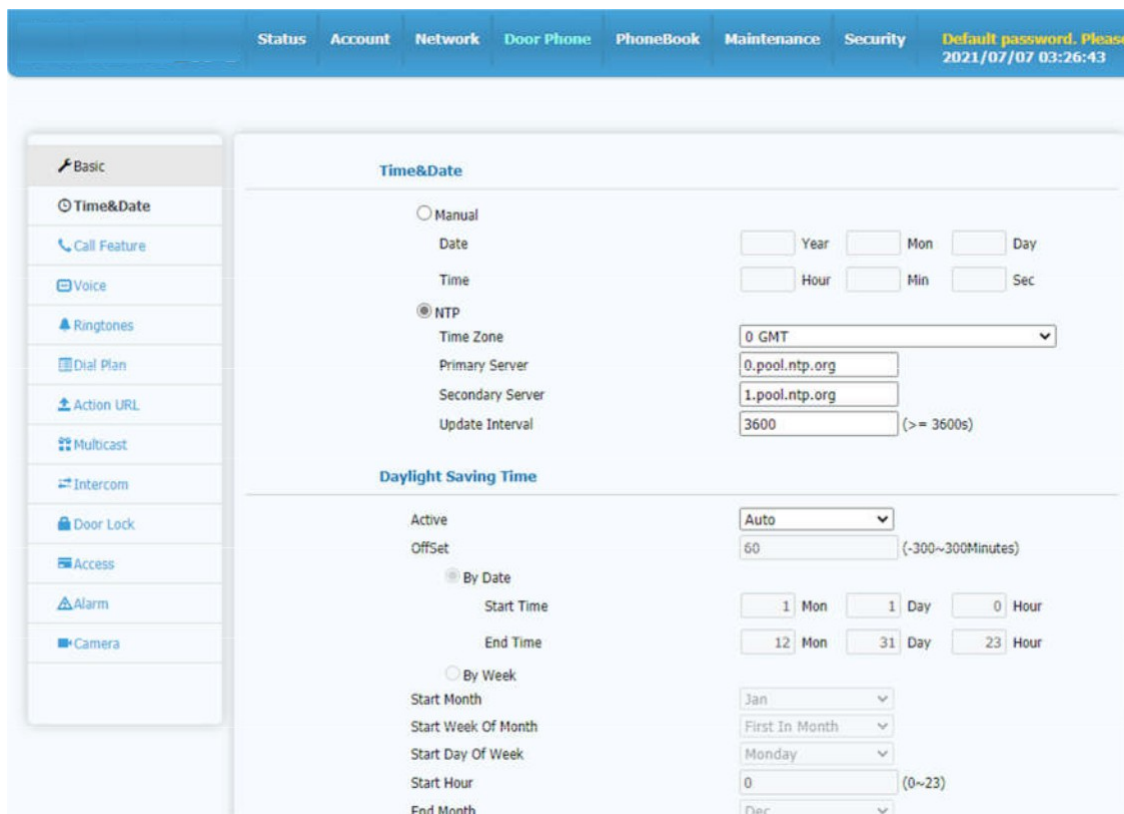

* Time&Date	Support Manual setting or NTP(Network Time Source), NTP support Time Zone Setting & Update Interval.
DST	Daily Saving Time

## 4.4.3 Call Feature

\*

Timeout For Answer	To configure Outgoing call, Incoming call, default is 60s, (30-120s)
Hang Up After RTP Time Out	To configure RTP Time out interval, Door phone will hang out if not receive command when RTP time out, default is 10s, (5-60s)
Call Button	To configure call button feature. <b>Call Button Selection:</b> can choose 2 call button. <b>Call Key Night:</b> Enable or Disable night call key. <b>Call Button Day1/2/3:</b> replace a phone number you want in Bright Day <b>Call Button Night:</b> replace a a phone number you want in Dark Day <b>Round Robbin Time Out:</b> Hang Out Time Interval, for example, if Call Button Day 1 hang out, it will go to Call Button Day 2, call button day 2 hang out, then go to Call Button Day 3
Day Night Setting	Set the start of day time and night time: <b>Day Start:</b> Starting point of daytime; <b>Night Start:</b> Starting point of night time. Key Pad Light& Call Button Selection configure are based on this Day Night Setting feature.

Security Staff Button	To configure call phone number to security staff.
Max call Duration	To configure the longest talk time, it will automatically hang up after a limited time (time range is 0~ 30minutes), 0 minutes means no automatic hang up.
Local RTP	To configure Local RTP port range, include min RTP port & max RTP port, (1024- 65535)
Hang Up After Open Door	To configure duration for the hang up after opening the door, default is 15s, (0-15s), 0 means hang up immediately after opening the door.
Web Call	To configure a call from web.

## 4.4.4 Voice

172.25.1.190/cgi/doorid=4&id=3  
\*

Echo Cancellor	To Enable & Disable Echo Cancellor, Voice Active Detection(VAD), Comfort Noise Generator(CNG)
Jitter Buffer	To Enable & Disable Jitter Buffer types, default is adaptive, (Fixed, Adaptive), if select Adaptive, default min delay is 0ms, default max delay is 300ms, Default normal delay is 120ms.
Volume	Mic Volume default is 5,(1-10) Speaker Volume default is 5,(1-10) Recorder Volume default is 2,(1-10)

#### AGC configuration

Line Out Volume default is 6,(1-10)

Key Tone Volume default is 5,(1-10)

Ringtone Volume default is 5,(1-10)

AGC(Automatic Gain Control) configure to approach target threshold, automatically control the gain.

**Tx direction AGC Enable:** Default is Enable,  
(Enabled、 Disabled)

**Tx Max Gain:** default is 0db, (0~30db)

**Tx Min Gain:** default is -40db, (-40~0db)

**Tx Target Level:** default is 120, (0~400)

**Rx direction AGC Enable:** Default is Enable,  
(Enabled、 Disabled)

**Rx direction AGC Enable:** default is 5, (0~30db)

**Rx Min Gain :** default is -40db, (-40~0db)

**Rx Target Level:** default is 120, (0~400)

**Handfree Auto AGC enable:** default is disable,  
(Enabled、 Disabled)

**Handfree Tx Max Gain:** default is 10db, (0~30db)

#### Audio Management

**Input Selection:** default Native Mic, (Native Mic, Line Input,Mixing)

**Speaker Out:** default enable, (Enabled、 Disabled)

**Line out:** default disable, (Enabled、 Disabled)

**Recorder Output:** default disable, (Enabled、 Disabled)

### 4.4.5 Ringtones

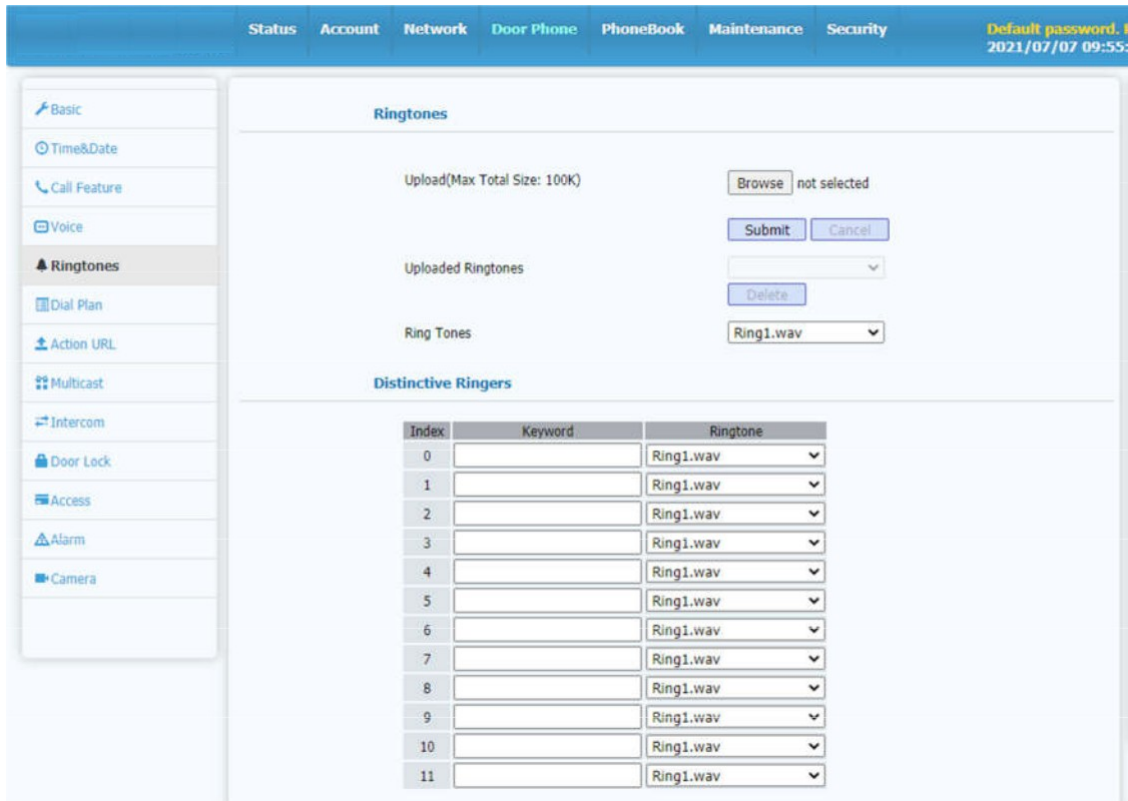

\*

Ringtones

Distinctive Ringers

Tones

Door Sound Select

To upload, delete, ringtones setting.

Different incoming call with different ringtones.

Choose different tones

Opening Prompt : default voice prompt,(voice prompt, default, disable)

**Closing Prompt:** default voice prompt,(voice prompt, default, disable)

**Issuing Prompt:** default voice prompt,(voice prompt, default, disable)

**Revoking Prompt:** default voice prompt,(voice prompt, default, disable)

**Open Failed Prompt:** default voice prompt,(voice prompt, default, disable)

**Door Sensor Prompt:** default voice prompt,(voice prompt, default, disable)

## 4.4.6 Dial Plan

Status Account Network **Door Phone** PhoneBook Maintenance Security Default password.  
2021/07/07 10:10

Basic  
Time&Date  
Call Feature  
Voice  
Ringtones  
**Dial Plan**  
Action URL  
Multicast  
Intercom  
Door Lock  
Access  
Alarm  
Camera

**Rules** Replace Rule

Index	Account	Prefix	Replace	
1				<input type="checkbox"/>
2				<input type="checkbox"/>
3				<input type="checkbox"/>
4				<input type="checkbox"/>
5				<input type="checkbox"/>
6				<input type="checkbox"/>
7				<input type="checkbox"/>
8				<input type="checkbox"/>
9				<input type="checkbox"/>
10				<input type="checkbox"/>

Page 1 Prev Next Add Edit Delete

**Area Code**

Code

Min Length  (1~15)

Max Length  (1~15)

Account

Submit Cancel

Door Phone Status Account Network **Door Phone** PhoneBook Maintenance Security Default password. Please  
2021/07/09 02:44:08

Basic  
Time&Date  
Call Feature  
Voice  
Ringtones  
**Dial Plan**  
Action URL  
Multicast  
Intercom  
Door Lock  
Access  
Alarm  
Camera

**Rules** Dial Now

Index	Account	Prefix	Replace	Dial Now Rule	
1	Auto	Dial Now		3	<input type="checkbox"/>
2					<input type="checkbox"/>
3					<input type="checkbox"/>
4					<input type="checkbox"/>
5					<input type="checkbox"/>
6					<input type="checkbox"/>
7					<input type="checkbox"/>
8					<input type="checkbox"/>
9					<input type="checkbox"/>
10					<input type="checkbox"/>

Add Edit Delete

**Dial Now Delay**

All Dial Delay

Dial Now Delay  (0~15s)

**Area Code**

Code

Min Length  (1~15)

Max Length  (1~15)

Account

Submit Cancel

\*

## Rules

To Configure and add “Replace Rules” & “Dial Now”

Account: account number

**Prefix** : Prefix means your keypad number

**Replace**: Replace means your room number

For example, set “Prefix= 1”, set “Prefix= 502”, after finished setting, you



can call 1 to do speed dial to room 502.

**All Dial Delay:** To configure all dial delay switch, can dial out only enable this switch, default is Enable (Enabled、Disabled) .

**Dial Now Delay:** To configure delay time after dial now, default is 3s, (1-15s), we suggest 1s.

### 4.4.7 Action URL

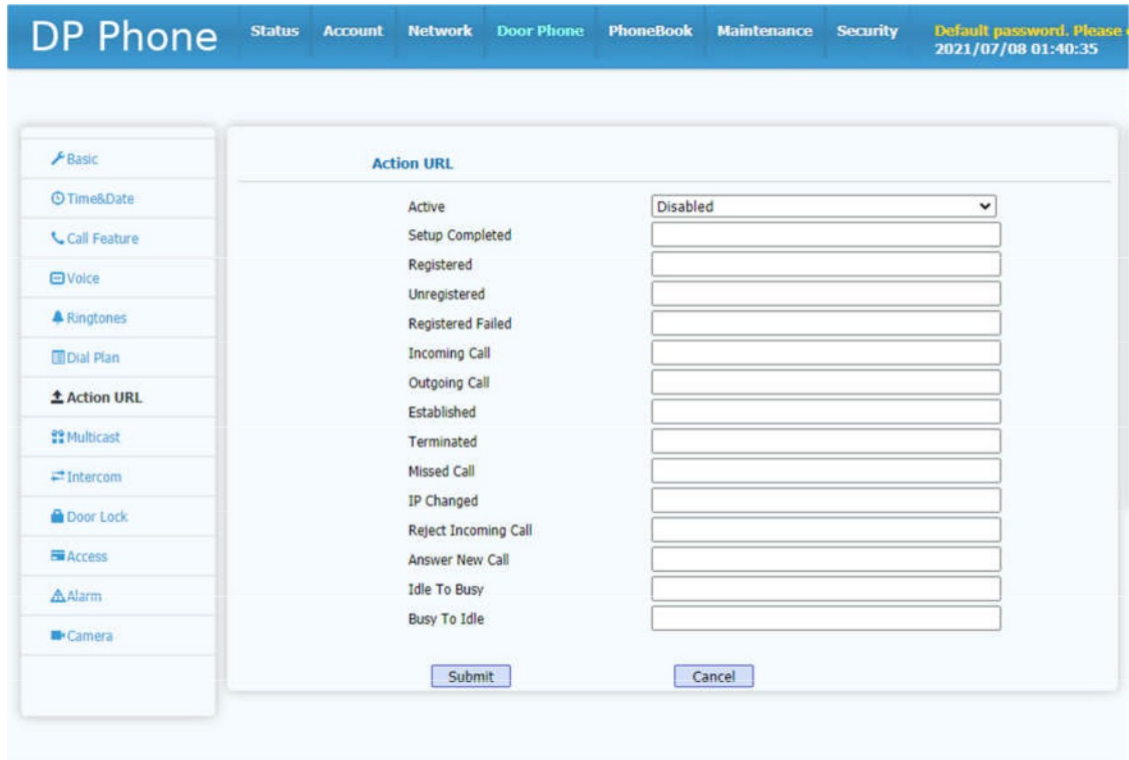

\*

Active	To configure Action URL, default is disable,(Enable, Disable)
Action URL	To configure different Action URL.

### 4.4.8 Multicast

To configure Multicast setting & Priority List parameters, see as below.

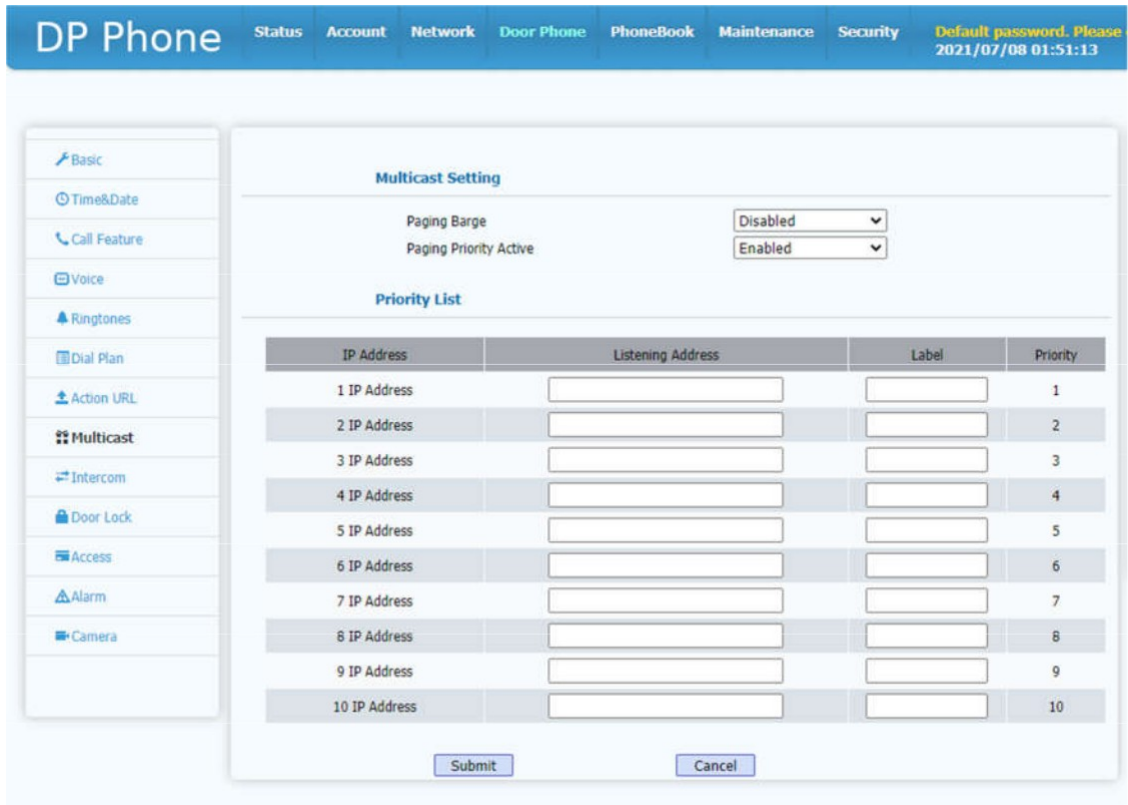

\*

Multicast setting

**Paging Barge:** To configure the Multicast Paging Barge Priority, default is Disable, (Disable, 1/2/3/4/5/6/7/8/9/10 )

**Paging Priority Active:** The switch of Paging Priority Active, default is Disable, (Enable, Disable)

Priority List

To display & configure Multicast Listening Address & Priority Level, Priority Level same as 1/2/3/4/5/6/7/8/9/10

## 4.4.9 Intercom

To configure Intercom feature parameters, intercom features based on address support, see as below.

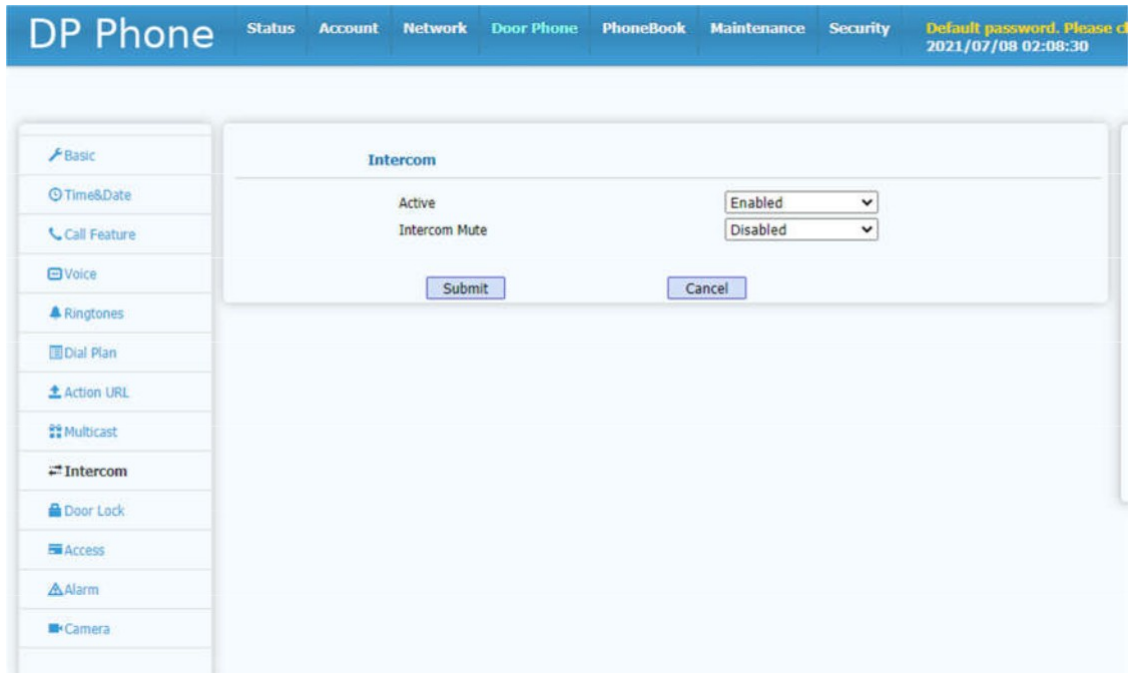

\*

Active	To configure Intercom switch, default is disable,(Enable, Disable)
Intercom Mute	To configure when intercom A call in, intercom B got mute or not.

#### 4.4.10 Door Lock

To display & configure user sensor & door lock statue, door lock control, auto opening setting, see as below.

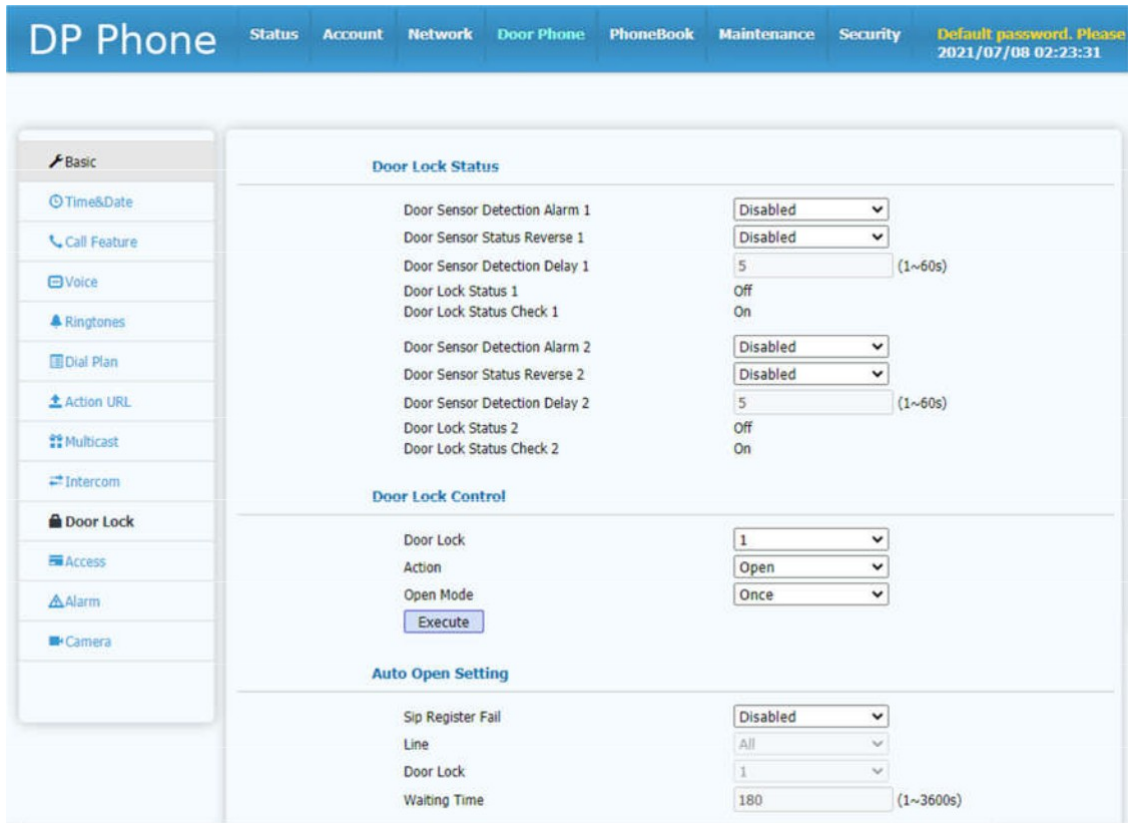

\*

Door Lock statuses

To configure door sensor Detection Alarm.

**Door Sensor Detection Alarm 1:** If door lock close, door sensor not close, then it will alert.

**Door Sensor Status Reverse 1:** default is Disable.

**Door Sensor Detection Delay 1:** To configure the duration after door lock close, default is 5s, (1-60s)

**Door Sensor Detection Alarm 2:** If door lock2 close, door sensor2 not close, then it will alert.

**Door Sensor Status Reverse 2:** default is Disable.

**Door Sensor Detection Delay 2:** To configure the duration after door lock 2 close, default is 5s, (1-60s)

Door Lock Control

To remote control door lock via Web.

**Door Lock:** To select the door you, (lock1,2,all)

**Action:** To configure relative door operation, default is Open, (Open, Close)。

**Open Mode:** default is Once, (Once, Always)。

Auto Open Setting

**SIP Register Fail:** To open the door lock when Sip Register Fail, default is Disable.

**Network Connect Fail:** To open the door lock when Network Connect Fail, default is Disable.

## 4.4.11 Access

To display & configure the DTMF Code & card access switches, see as below.

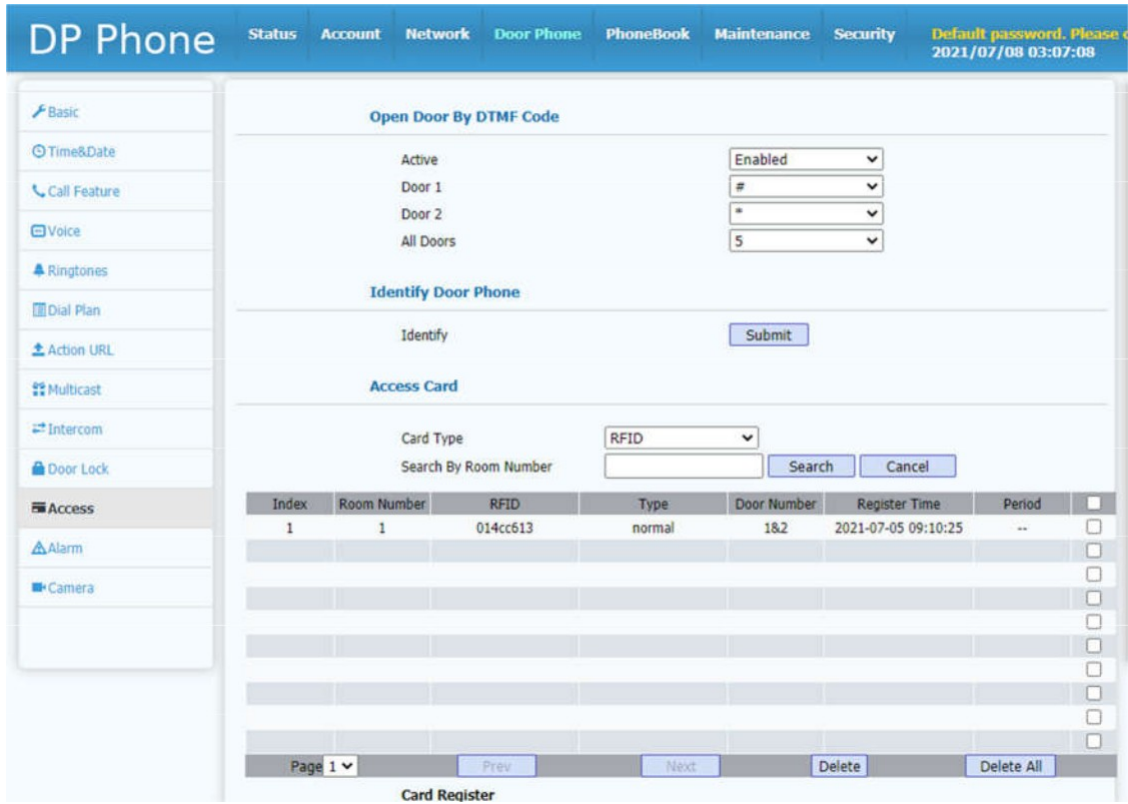

\*

#### Open Door by

DTMF Code

**Active** : default is EnableEnabled , ( , Disabled ) 。

**Door 1:** To configure Door 1's DTMF code, (0~9、\*、#)

**Door 2:** To configure Door 1's DTMF code, (0~9、\*、#)

**Identify Door Phone** Click "Submit" to identify Door Phone, then device will "bee bee" to help you know which door phone.

#### Access Card

To display & configure the card type and card register.

**Card Type:** IC&ID card.

**Password:** no need RFID card.

**Search By Room Number:** search feature.

**Card register:** Card user type include Normal, Admin, Temp.

**Note:** Admin card only for card issuing and card revoking, cannot use for opening the door. Temp card valid date from 30min- 1 month.

#### Open Door By

HTTP

To configure the open door via http protocol.

### 4.4.12 Alarm

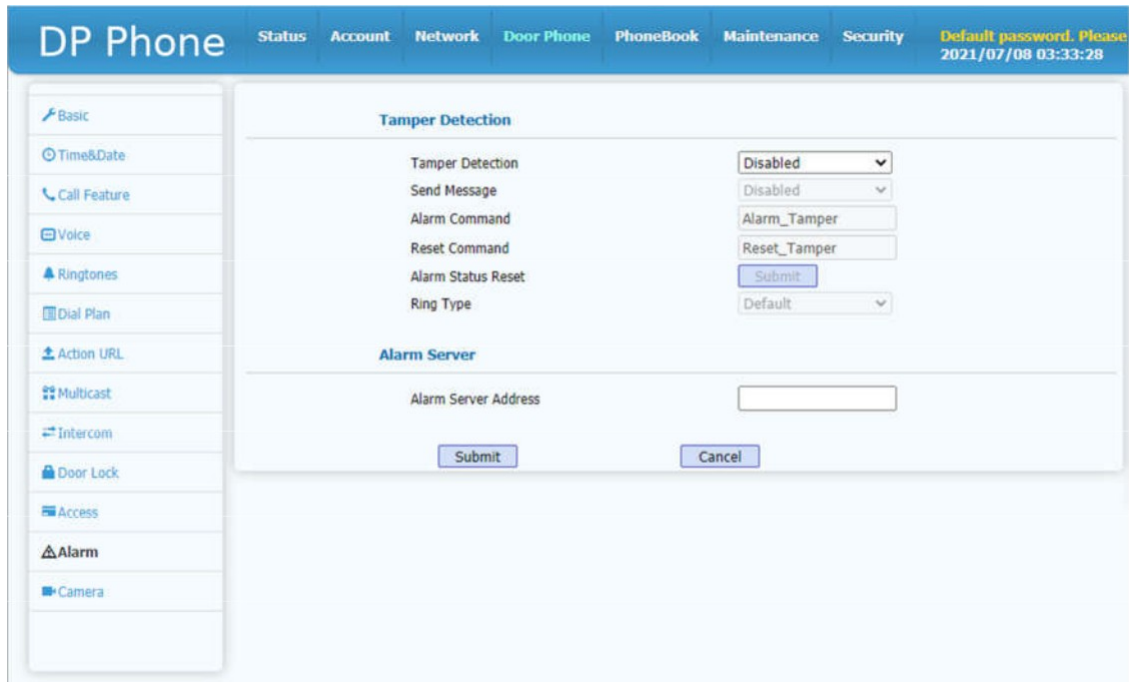

\*

Tamper Detection

**Tamper Detection:** default is Disable, (Enabled、Disabled)

**Send Message:** send message after door phone dismantled.

**Alarm Command:** default is Alarm\_Tamper。

**Reset Command:** default is Reset\_Tamper。

**Alarm Status Reset:** To reset via Web.

**Ring Type:** default

Alarm Server

To configure Alarm Server Address, it will auto send message to configured server once alert.

### 4.4.13 Camera

To configure LAN camera UUID & WLAN camera UUID, camera resolution, see as below.

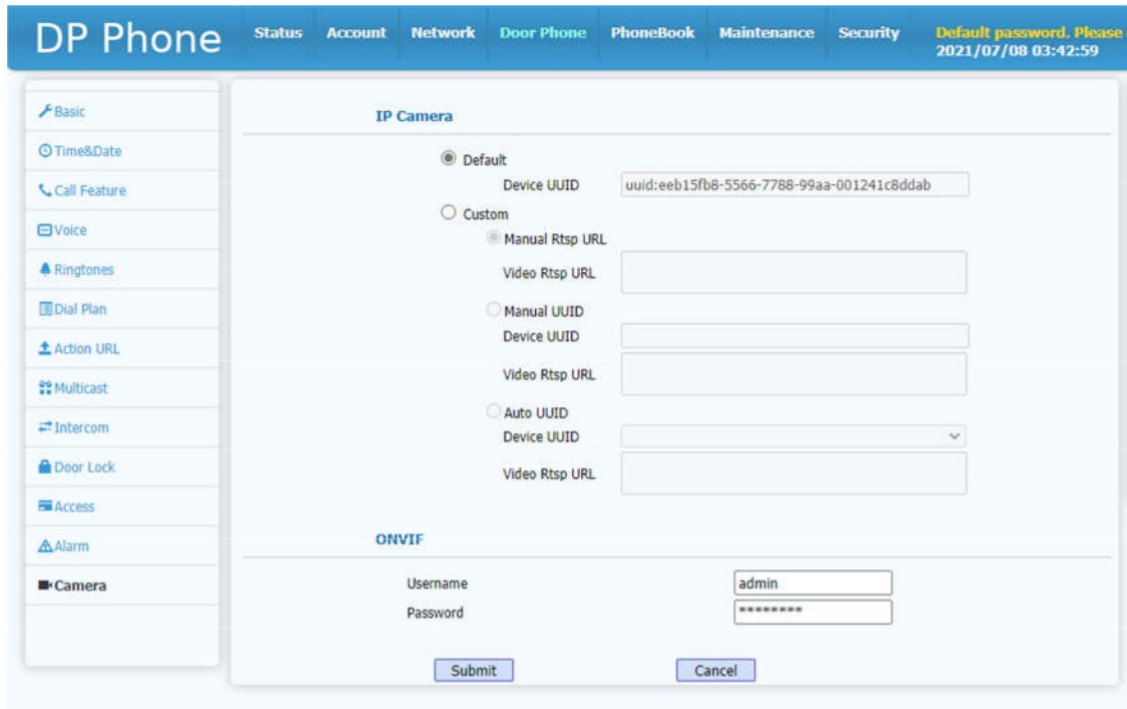

\*

IP Camera

**Resolution:** default is 1280X720.

**Default UUID:** fixed, can not change.

**Custom:** To auto configure WLAN camera UUID & URL address of RTSP. Or manual configure WLAN camera UUID & URL address of RTSP.

ONVIF

To connect Onvif camera via its username & password.

## 4.5 PhoneBook

PhoneBook on Web is to display & configure local PhoneBook, remote PhoneBook, call record lists and Broadsoft PhoneBook.

### 4.5.1 Local Book

Local book display & configure contact local group, local contact add and delete, Local contact include All Contact, White List, Black List, Favorites, it also support 3 types export formats, see as below.

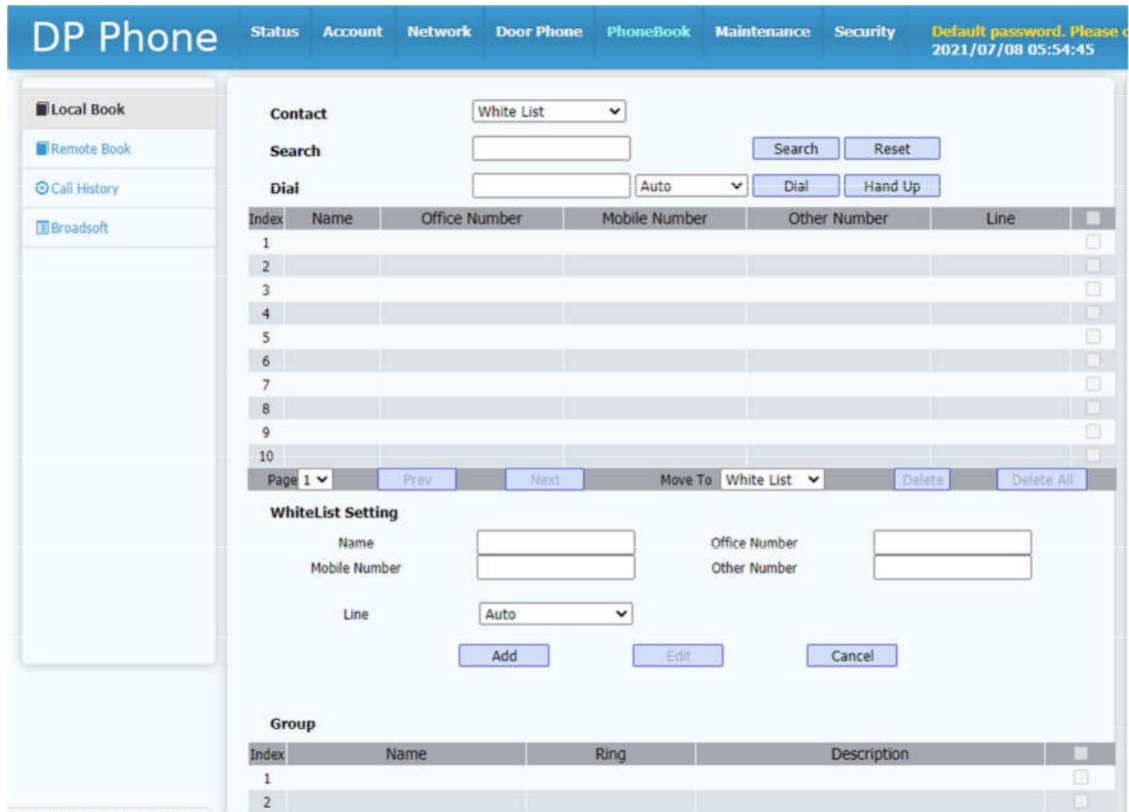

\*

Contact Default is White list, (All Contact, White List, Black List, Favorites)

Search Search Contact

Dial Input a phone number here can call out & hang up via Web

List setting To edit contact's name, number.

Group To configure contact group, max support 10 groups, and edit name, ring, and description for each group.

Export Format ( )

To support 3 types, .XML/.CSV/.VCF

Import & Export To Import & Export for contact, white list & black list.

Note: after select White List, door phone only can call out to contact from white list.

## 4.5.2 Remote Book

To display & configure remote door phone and its Refresh Interval, see as below.



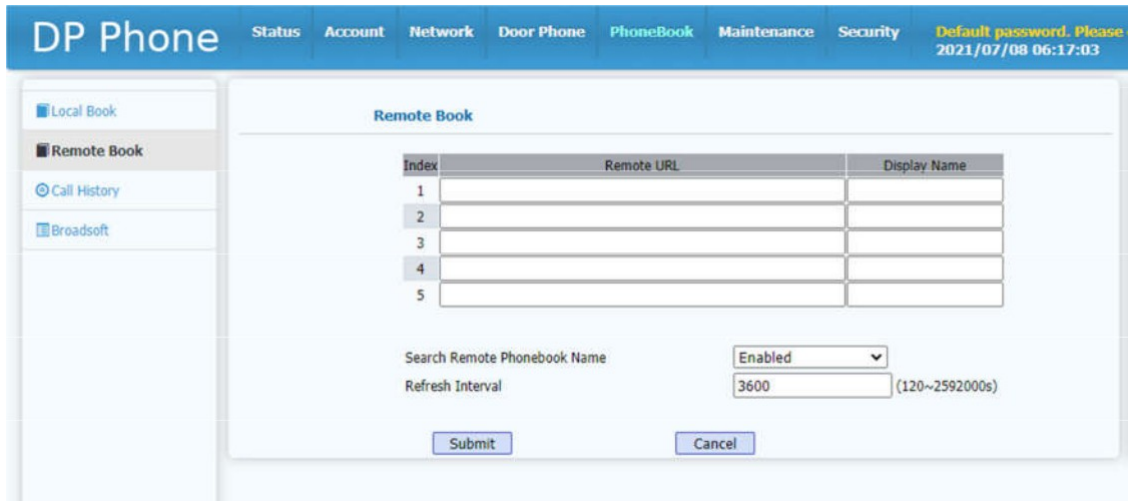

\*

Remote Book

To configure remote book URL address & display name.

Search Remote  
Phonebook Name  
Refresh Interval

Default is Enable, (Enable, Disable)

The Refresh Interval for receive remote Phonebook name, default is 3600s, (120s- 2592000s)

### 4.5.3 BroadSoft

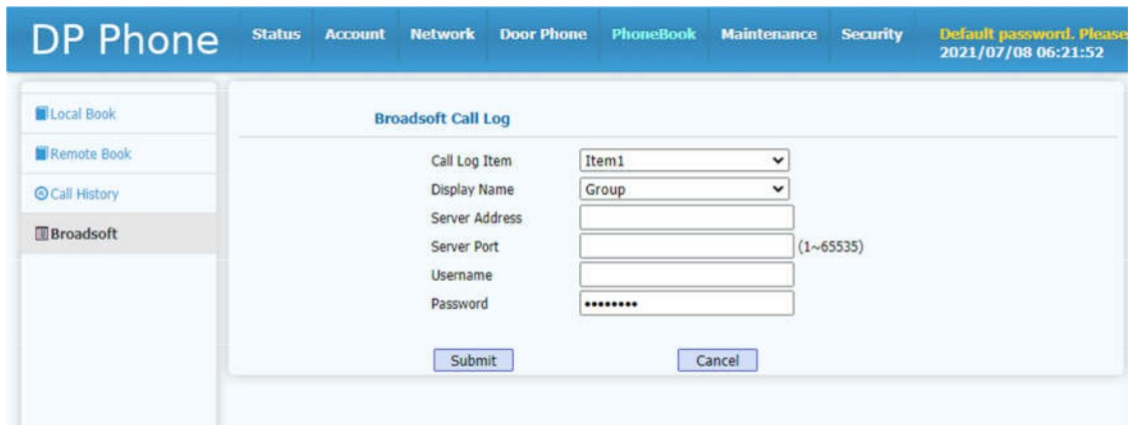

\*

Call Log Item

Default Item 1, (Item1/2/3/4/5/6)

Display Name

To display Group, Enterprise, Group Common, Enterprise Common, Personal

Server Address

Server IP address

Server Port

N/A

Username/Password

N/A

## 4.5.4 Call History

To display & classify different call log, include All, Dialed, Received, Missed, Forwarded, see as below,

The screenshot shows the 'DP Phone' interface with the 'Call History' section active. A dropdown menu is open over the 'Type' column, showing options: All, Dialed, Received, Missed, and Forwarded. The table below lists 12 received calls.

Index	Type	Time	Local Identity	Name	Number	Call Duration	Account	RTP Send	RTP Recv	Lost (%)	Jitter (ms)	Delay (ms)	
1	Received	2021-07-08 06:01:49	7001	7003	7003@172.25.23.140	00:00:05	1	0	0	0	0	0	<input type="checkbox"/>
2	Received	2021-07-08 05:59:59	7001	7003	7003@172.25.23.140	00:00:10	1	0	0	0	0	0	<input type="checkbox"/>
3	Received	2021-07-08 05:57:05	7001	7003	7003@172.25.23.140	00:00:09	1	0	0	0	0	0	<input type="checkbox"/>
4	Received	2021-07-08 05:51:42	7001	7003	7003@172.25.23.140	00:00:06	1	0	0	0	0	0	<input type="checkbox"/>
5	Received	2021-07-08 05:47:03	7001	7003	7003@172.25.23.140	00:00:09	1	0	0	0	0	0	<input type="checkbox"/>
6	Received	2021-07-08 03:58:51	7001	7003	7003@172.25.23.140	00:00:04	1	0	0	0	0	0	<input type="checkbox"/>
7	Received	2021-07-08 03:58:26	7001	7003	7003@172.25.23.140	00:00:06	1	0	0	0	0	0	<input type="checkbox"/>
8	Received	2021-07-08 03:50:41	7001	7003	7003@172.25.23.140	00:00:15	1	374	501	0	2	0	<input type="checkbox"/>
9	Received	2021-07-08 03:49:58	7001	7003	7003@172.25.23.140	00:00:10	1	0	0	0	0	0	<input type="checkbox"/>
10	Received	2021-07-08 03:48:38	7001	7003	7003@172.25.23.140	00:00:07	1	0	0	0	0	0	<input type="checkbox"/>
11	Received	2021-07-08 03:48:21	7001	7003	7003@172.25.23.140	00:00:05	1	0	0	0	0	0	<input type="checkbox"/>
12	Received	2021-07-08 03:22:28	7001	7003	7003@172.25.23.140	00:00:08	1	0	0	0	0	0	<input type="checkbox"/>

The screenshot shows the 'DP Phone' interface with the 'Call History' section active. A red box highlights the number '7003@172.25.23.140' in the 'Number' column of the first row. A pop-up dialog box is displayed over the table, asking 'Are you sure to dial?' with '确定' (Confirm) and '取消' (Cancel) buttons.

Index	Type	Time	Local Identity	Name	Number	Call Duration	Account	RTP Send	RTP Recv	Lost (%)	Jitter (ms)	Delay (ms)	
1	Received	2021-07-08 06:01:49	7001	7003	7003@172.25.23.140	00:00:05	1	0	0	0	0	0	<input type="checkbox"/>
2	Received	2021-07-08 05:59:59	7001	7003	7003@172.25.23.140	00:00:10	1	0	0	0	0	0	<input type="checkbox"/>
3	Received	2021-07-08 05:57:05	7001	7003	7003@172.25.23.140	00:00:09	1	0	0	0	0	0	<input type="checkbox"/>
4	Received	2021-07-08 05:51:42	7001	7003	7003@172.25.23.140	00:00:06	1	0	0	0	0	0	<input type="checkbox"/>

Call History Types Default is All, (All, Dialed, Received, Missed, Forwarded)

Call out & Hang up from Call History Click the port number in Call History, a Message will pop up “Are you sure to dial?”

## 4.6 Maintenance

To display & configure doorphone maintenance feature, include Upgrade, Auto Provision, System Log, Network Capture, Configuration, PnP, Call Event, Reboot and Door Log.

### 4.6.1 Upgrade

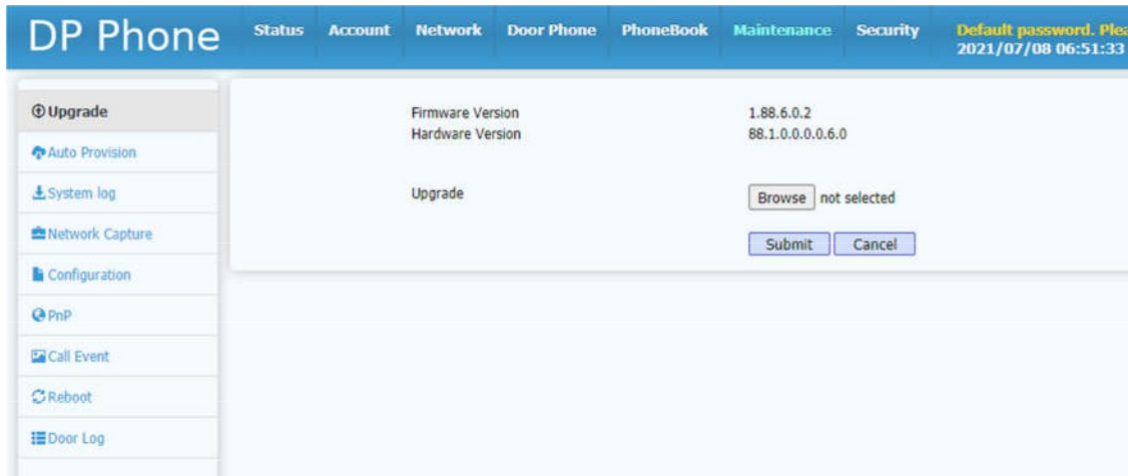

\*

Version

The doorphone firmware & hardware version.

Upgrade

Click Browse to select a version file to upgrade from LAN.

## 4.6.2 Auto Provision

Auto Provision, to use for configuration file upgrade, upgrade mode setting and DHCP setting to receive SIP server address, see as below,

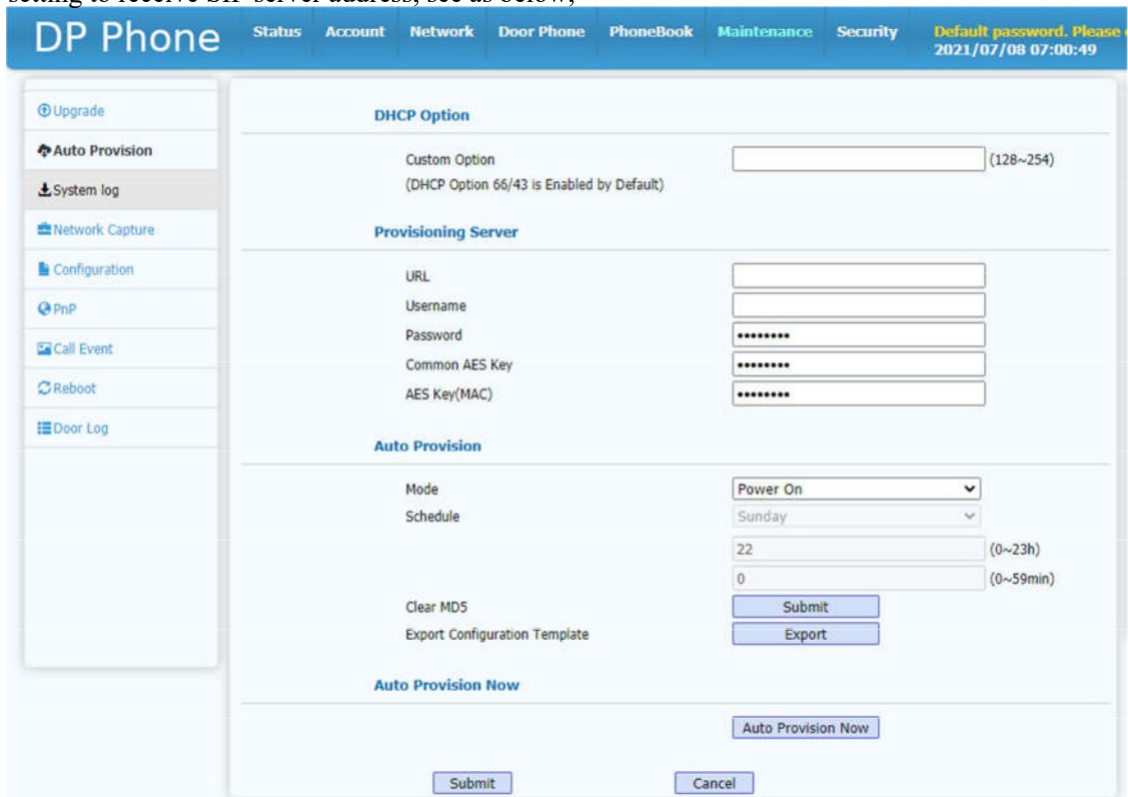

\*

DHCP Option	To receive server ip address via DHCP custom option.
Provisioning server	To input the server URL address which from the server you want, then fill up the username & password, Common AES Key, MAC-AES key. Then select “Power On” in Auto Provision and click “Auto Provision Now”, door phone will auto grade.
Auto Provision	Auto Provision Mode default is Power On, means doorphone will auto download configuration file followed server URL address. <b>Auto Provision Mode</b> : Disable, Power On, Repeatedly, Power On +Repeatedly, Hourly Repeat, Power On+ Hourly Repeat) <b>Schedule:</b> The interval of Auto Provision Mode <b>Clear MD5:</b> Can upgrade again after Clear MD5 <b>Export AutoP Configuration Template:</b> AutoP Configuration Template can be edit, and then put into server URL address.
Auto Provision Now	N/A

### 4.6.3 System Log

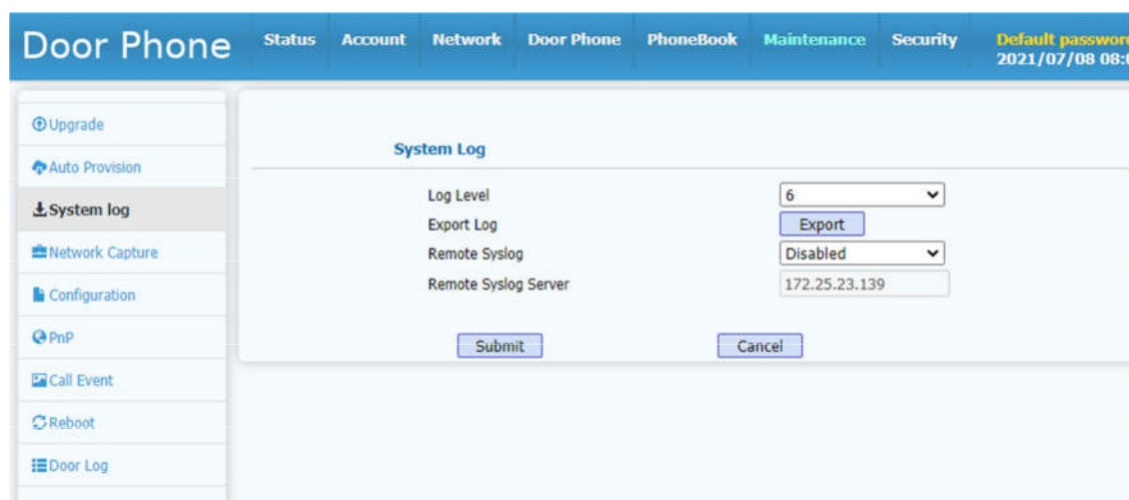

\*

Log Level	Default level is 3, (Level 1-7), higher level, more secure.
Export Log	To troubleshoot after export log.
Remote Syslog	To send the doorphone system log to remote syslog server after select Enable.

### 4.6.4 Network Capture

Network Capture now support 2 interfaces, default is “eth0”,another is “VPN”.

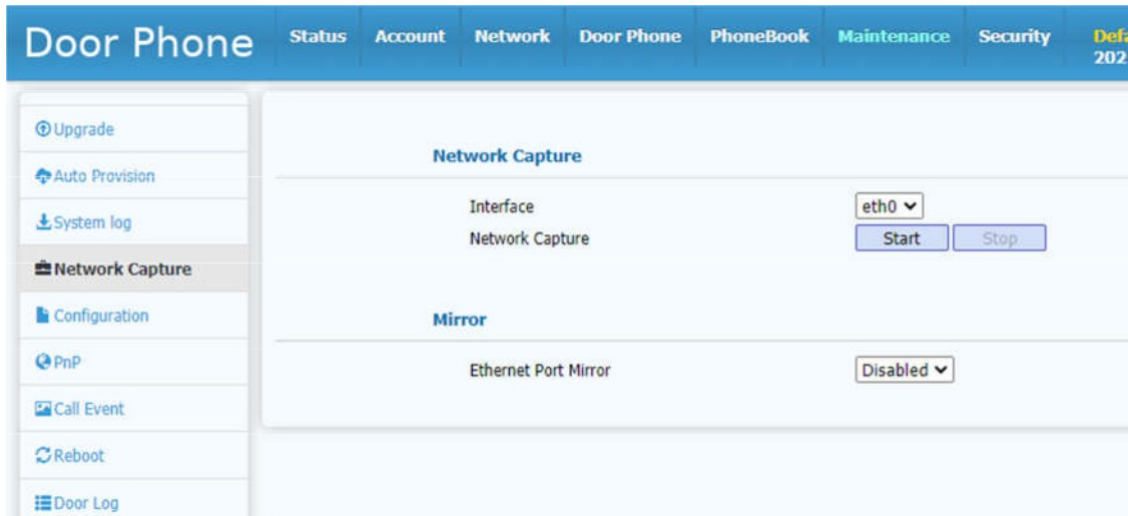

## 4.6.5 Configuration

To import & export configuration file, and the reset to factory setting, see as below.

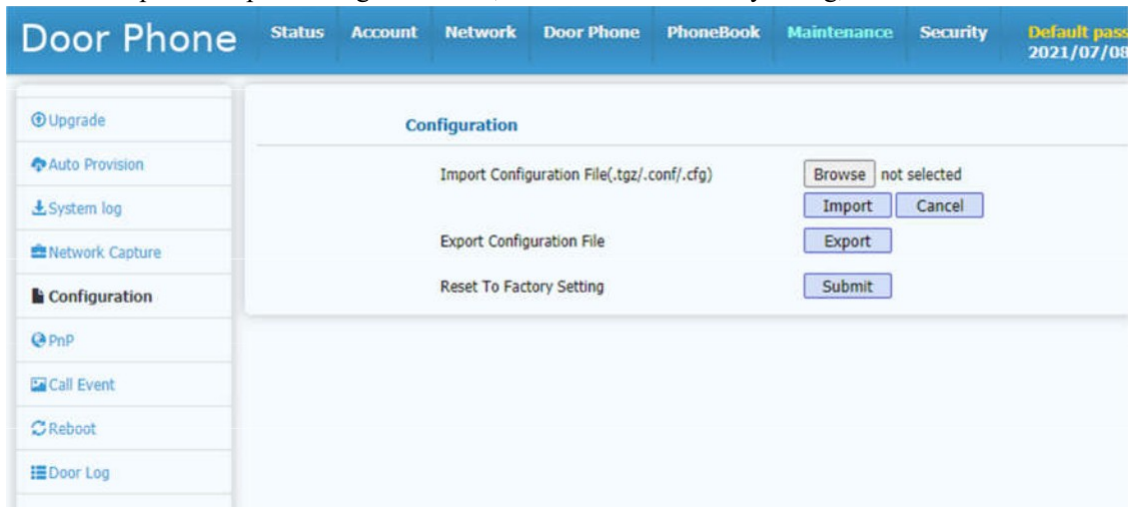

## 4.6.6 PnP

Doorphone send subscribed news regularly to the PnP server, and PnP server will deploy the configuration files to doorphone, doorphone parse the configuration files and auto upgrade

### 4.6.7 Call Event

Trough CDR, FTP or http URL, Call Event can push service to server ip address.

### 4.6.8 Reboot

To reboot doorphone.

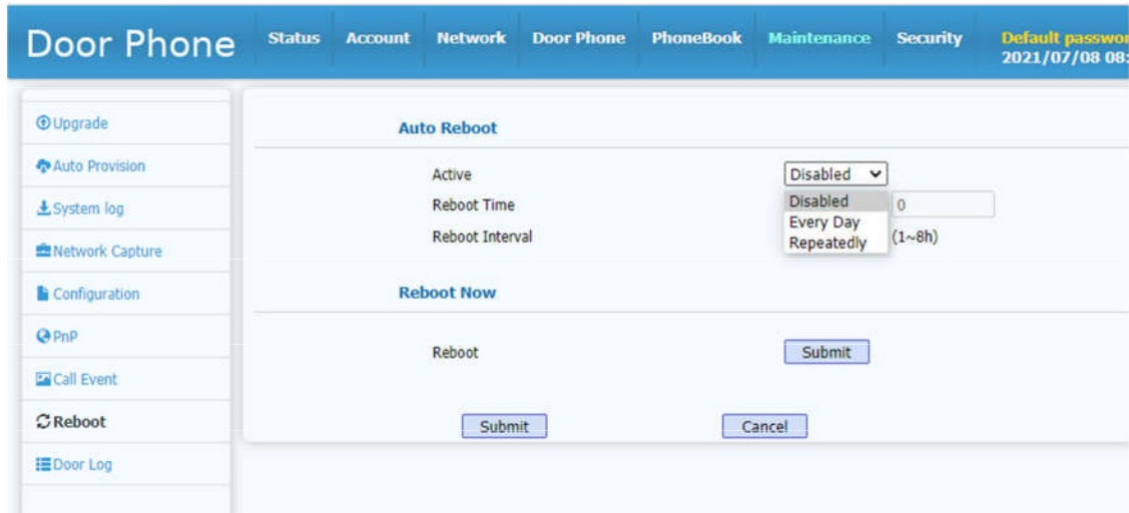

\*

Auto Reboot

**Active:** To configure Disable, (Disable, Every Day, Repeatedly)

**Reboot Time:** If select “Active- Every Day”, then you can set this Reboot Time, for example, if set “22:00”, then doorphone will reboot at 22:00 every day.

**Reboot Interval:** If select”Active-Repeatedly”, then you can set this Reboot Interval, for example, if you set “8h”, then door phone will reboot every 8h.

Reboot Now

Restart.

## 4.6.9 Door Log

To display door access record, currently support All, Card Reader, Password, DTMF, Web, Indoor, SIP Fail, Net Fail, Server Temp Password, Server Dynamic Password, and also support door open record export.



Door Phone							Status	Account	Network	Door Phone	PhoneBook	Maintenance	Security	Default password. Please ch 2021/07/08 10:16:41
<div style="display: flex; justify-content: space-between;"> <span>Upgrade</span> <span>Auto Provision</span> <span>System log</span> <span>Network Capture</span> <span>Configuration</span> <span>PnP</span> <span>Call Event</span> <span>Reboot</span> <span>Door Log</span> </div>														
Door Open History			All	Export										
Index	Type	Door Number	Name	Number	Status									
1	DTMF	1	7003@172.25.23.140	7003@172.25.23.140	Success									
2	DTMF	2	7003@172.25.23.140	7003@172.25.23.140	Success									
3	DTMF	1&2	7003@172.25.23.140	7003@172.25.23.140	Success									
4	Card Reader	1&2	1	014cc613	Success									
5	DTMF	1&2	172.25.1.184	172.25.1.184	Success									
6	DTMF	1&2	2021-07-06 05:40:16	172.25.1.184	Success									
7	DTMF	1&2	2021-07-06 05:39:50	172.25.1.184	Success									
8	DTMF	1	2021-07-06 03:57:55	172.25.1.184	Success									
9	DTMF	1	2021-07-06 03:57:42	172.25.1.184	Success									
10	DTMF	1	2021-07-06 03:56:58	172.25.1.184	Success									
11	DTMF	1&2	2021-07-06 03:49:15	172.25.1.184	Success									
12	DTMF	2	2021-07-06 03:49:13	172.25.1.184	Success									
13	DTMF	1	2021-07-06 03:49:12	172.25.1.184	Success									
14	DTMF	1&2	2021-07-06 03:46:42	172.25.1.184	Success									
15	DTMF	2	2021-07-06 03:46:40	172.25.1.184	Success									
16	DTMF	1	2021-07-06 03:46:37	172.25.1.184	Success									

## 4.7 Security

To display & configure the Web Password Modify, Web Session, SSH, Remote Control Address IP list, and Web Server Certificate, Client Certificate.

### 4.7.1 Security Basic

To display & configure the Web Password Modify, Web Session, SSH, Remote Control Address IP list.



\*

Web Password Modify	Support 2 accounts, admin & user
Web Session	To configure interval of Web Session time out, means Web will back to the login page if long times no operation.
SSH	To configure SSH login into the shell web page, default is Enable.
Remote Control Allowed Access IP List	To configure remote control allowed access IP list to the doorphone.

## 4.7.1 Security Advanced

To configure upload the Web Server Certificate & Client Certificate, also check these certificates are valid or not, see as below.

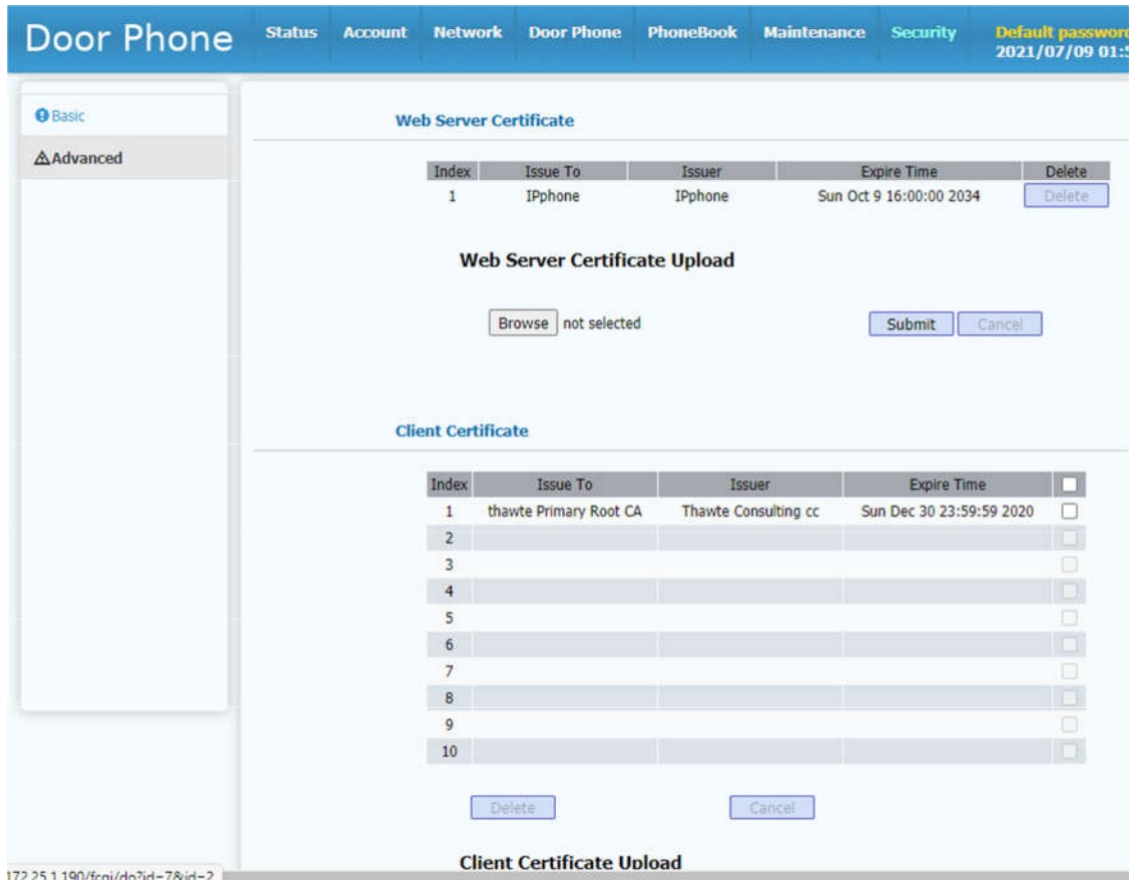

## Appendix 1: Fault Resolution

### Problem 1: Speed dial button light is not on

Check the AC power adapter to make sure it is the original power adapter.  
 Check the power outlet. Make sure that the power supply of the outlet into which you plug the device is working properly. Try to plug another device into the outlet to make sure it can power up normally.

### Problem 2: Can't access the web interface

Check the connection between the PC port of the device and the computer network port to make sure everything is working.

Check if the IP address of the device is correct.

If it is a LAN, make sure that there is no conflict with the IP addresses of other devices on the network.

### Problem 3: Unable to call

Please check the network connection status of the device, if there is any abnormality, please check the network connection;

If the network connection is normal, please check whether the device has been successfully registered;

If the network connection and registration are normal, please confirm whether the dialing rules are correct, or contact the service op.

## Appendix 2: Time Zone

Time Zone	Time Zone Name
-11	Samoa
-10	United States-Hawaii-Aleutian
-10	United States-Alaska-Aleutian
-9	United States-Alaska Time
-8	Canada(Vancouver,Whitehorse)
-8	Mexico(Tijuana,Mexicali)
-8	United States-Pacific Time
-7	Canada(Edmonton,Calgary)
-7	Mexico(Mazatlan,Chihuahua)
-7	United States-Mountain Time
-7	United States-MST no DST
-6	Canada-Manitoba(Winnipeg)
-6	Chile(Easter Islands)
-6	Mexico(Mexico City,Acapulco)
-6	United States-Central Time
-5	Bahamas(Nassau)
-5	Canada(Montreal,Ottawa,Quebec)
-5	Cuba(Havana)
-5	United States-Eastern Time
-4:30	Venezuela(Caracas)
-4	Canada(Halifax,Saint John)
-4	Chile(Santiago)

-4	Paraguay(Asuncion)
-4	United Kingdom-Bermuda(Bermuda)
-4	United Kingdom(Falkland Islands)
-4	Trinidad&Tobago
-4	Curaçao
-3:30	Canada-New Foundland(St.Johns)
-3	Denmark-Greenland(Nuuk)
-3	Argentina(Buenos Aires)
-3	Brazil(no DST)
-3	Brazil(DST)
-2	Brazil(no DST)
-1	Portugal(Azores)
0	GMT
0	Greenland
0	Denmark-Faroe Islands(Torshaven)
0	Ireland(Dublin)0 Portugal(Lisboa,Porto,Funchal)
0	Spain-Canary Islands(Las Palmas)
0	United Kingdom(London)
0	Morocco
1	Poland(Warsaw)
1	Albania(Tirane)
1	Austria(Vienna)
1	Belgium(Brussels)
1	Caicos
1	Chatham

1	Croatia(Zagreb)
1	Czech Republic(Prague)
1	Denmark(Copenhagen)
1	France(Paris)
1	Germany(Berlin)
1	Hungary(Budapest)
1	Italy(Rome)
1	Luxembourg(Luxembourg)
1	Makedonia(Skopje)
1	Netherlands(Amsterdam)
1	Namibia(Windhoek)
2	Estonia(Tallinn)
2	Finland(Helsinki)
2	Gaza Strip(Gaza)
2	Greece(Athens)
2	Israel(Tel Aviv)
2	Jordan(Amman)
2	Latvia(Riga)
2	Lebanon(Beirut)
2	Moldova(Kishinev)
2	Russia(Kaliningrad)
2	Romania(Bucharest)
2	Syria(Damascus)
2	Turkey(Ankara)
2	Ukraine(Kyiv,Odessa)

3	East Africa Time
3	Iraq(Baghdad)
3	Russia(Moscow)
3	30 Iran(Teheran)
4	Armenia(Yerevan)
4	Azerbaijan(Baku)
4	Georgia(Tbilisi)
4	Kazakstan(Aqtau)
4	Russia(Samara)
5	Kazakstan(Aqtobe)
5	Kyrgyzstan(Bishkek)
5	Pakistan(Islamabad)
5	Russia(Chelyabinsk)
5	Russia(Yekaterinburg)
+5:30	India(Calcutta)
6	Kazakstan(Astana,Almaty)
6	Russia(Novosibirsk,Omsk)
7	Russia(Krasnoyarsk)
7	Thailand(Bangkok)
8	China(Beijing)
8	Singapore(Singapore)
8	Australia(Perth)
9	Korea(Seoul)
9	Japan(Tokyo)
+9:30	Australia(Adelaide)

+9:30	Australia(Darwin)
10	Australia(Sydney,Melbourne,Canberra)
10	Australia(Brisbane)
10	Australia(Hobart)
10	Russia(Vladivostok)
+10:30	Australia(Lord Howe Islands)
11	New Caledonia(Noumea)
12	New Zealand(Wellington,Auckland)
+12:45	New Zealand(Chatham Islands)
13	Tonga(Nukualofa)